

| | | |
|--|---|--|
| DIMENSIONS ARE IN INCHES UNLESS OTHERWISE SPECIFIED TOLERANCES: FRACTIONAL $\pm 1/64"$ ANGULAR: BEND $\pm 0.1\%$ THREE PLACE DECIMAL $\pm .005"$ | File Location: C:\Solidworks Working Directory\ | |
| | MATERIAL 18 Gauge CRS FINISH Cardinal Black Hammer Epoxy E311-BK04 Semi-Gloss Hammer DO NOT SCALE DRAWING | |

| | NAME | DATE |
|---------|-------------|-----------|
| DRAWN | W.Dippenaar | 1/27/2014 |
| CHECKED | S.Johnson | 1/27/2014 |
| REV. | | 09 |

THE INFORMATION CONTAINED IN THIS DRAWING IS THE SOLE PROPERTY OF JOHNSON SYSTEMS INC. ANY REPRODUCTION IN PART OR AS A WHOLE WITHOUT THE WRITTEN PERMISSION OF JOHNSON SYSTEMS INC. IS PROHIBITED.

JOHNSON SYSTEMS INC.
 1923 Highfield Crescent SE.
 Calgary, Alberta
 Canada T2G 5M1
 (403) 287-8003
 (403) 287-9003 Fax

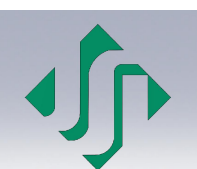

Part # J-PACK DP Complete
 Note: -----

SCALE:1:5

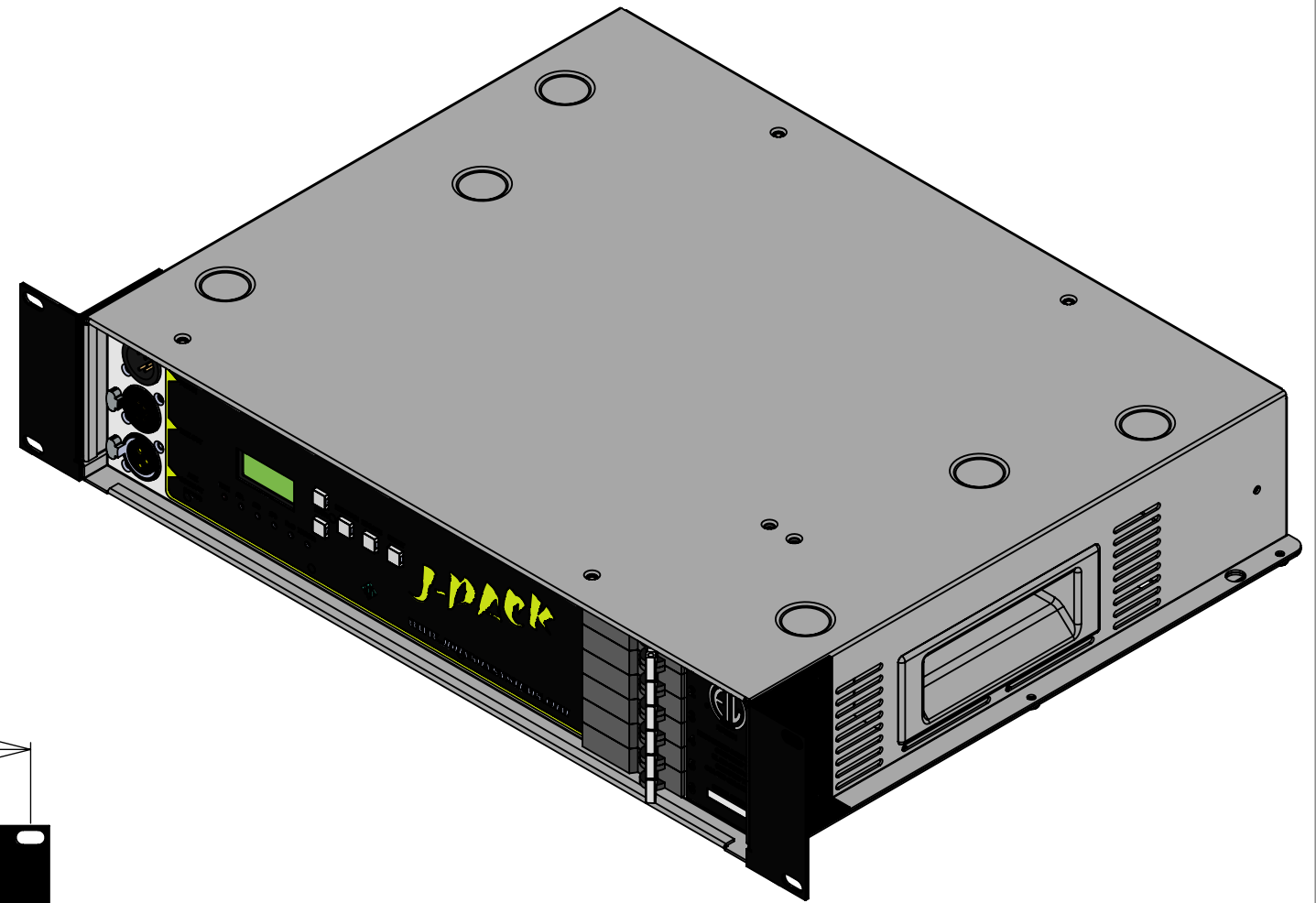
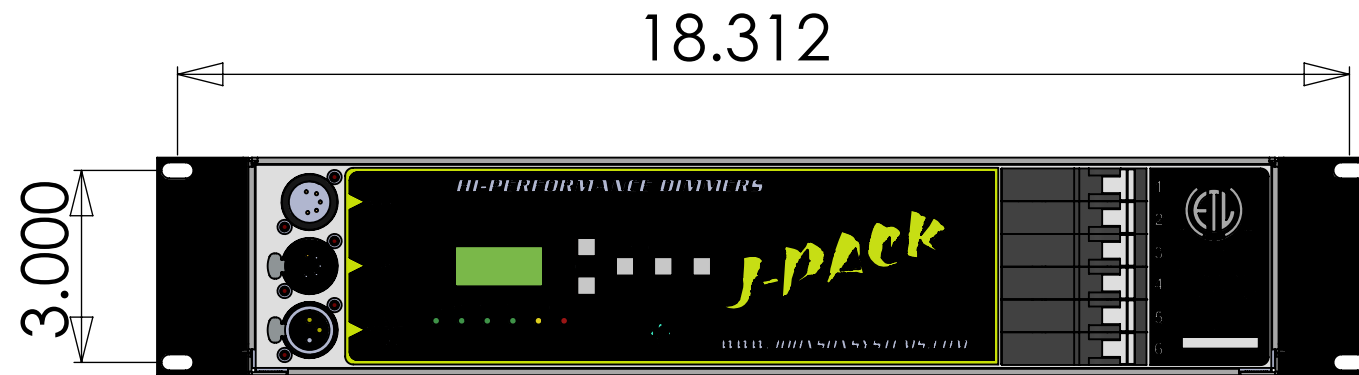

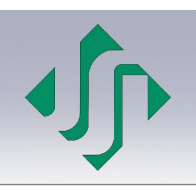
| | | | | | |
|--|--|-----------|------|---|---|
| DIMENSIONS ARE IN INCHES UNLESS OTHERWISE SPECIFIED TOLERANCES: FRACTIONAL ± 1/64" ANGULAR: BEND ±01% THREE PLACE DECIMAL ± .005" MATERIAL 18 Gauge CRS FINISH Cardinal Black Hammer Epoxy E311-BK04 Semi-Gloss Hammer DO NOT SCALE DRAWING | File Location: C:\Solidworks Working Directory\ | NAME | DATE | JOHNSON SYSTEMS INC. 1923 Highfield Crescent SE. Calgary, Alberta Canada T2G 5M1 (403) 287-8003 (403) 287-9003 Fax Part # J-PACK DP Complete Note: ----- |  |
| | DRAWN W.Dippenaar 1/27/2014 CHECKED S.Johnson 1/27/2014 REV. 09 THE INFORMATION CONTAINED IN THIS DRAWING IS THE SOLE PROPERTY OF JOHNSON SYSTEMS INC. ANY REPRODUCTION IN PART OR AS A WHOLE WITHOUT THE WRITTEN PERMISSION OF JOHNSON SYSTEMS INC. IS PROHIBITED. | SCALE:1:5 | | | |

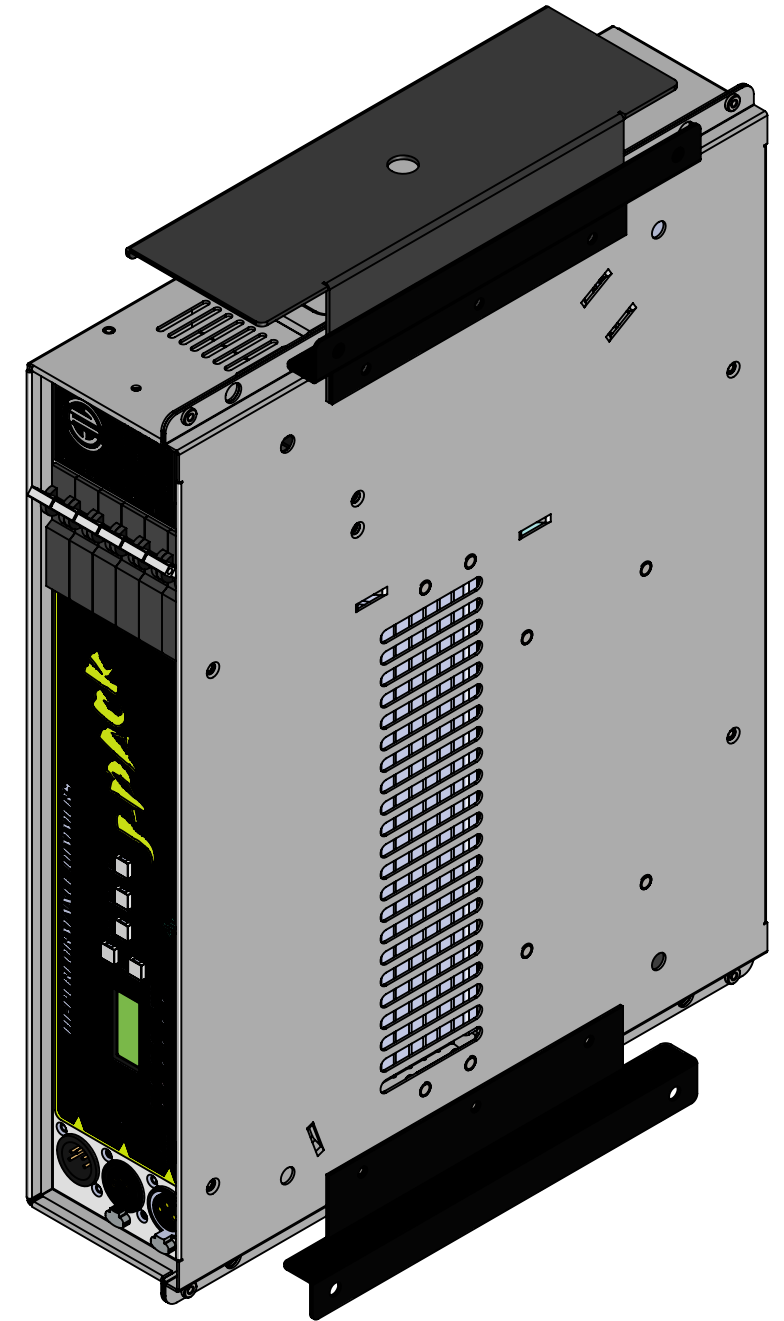
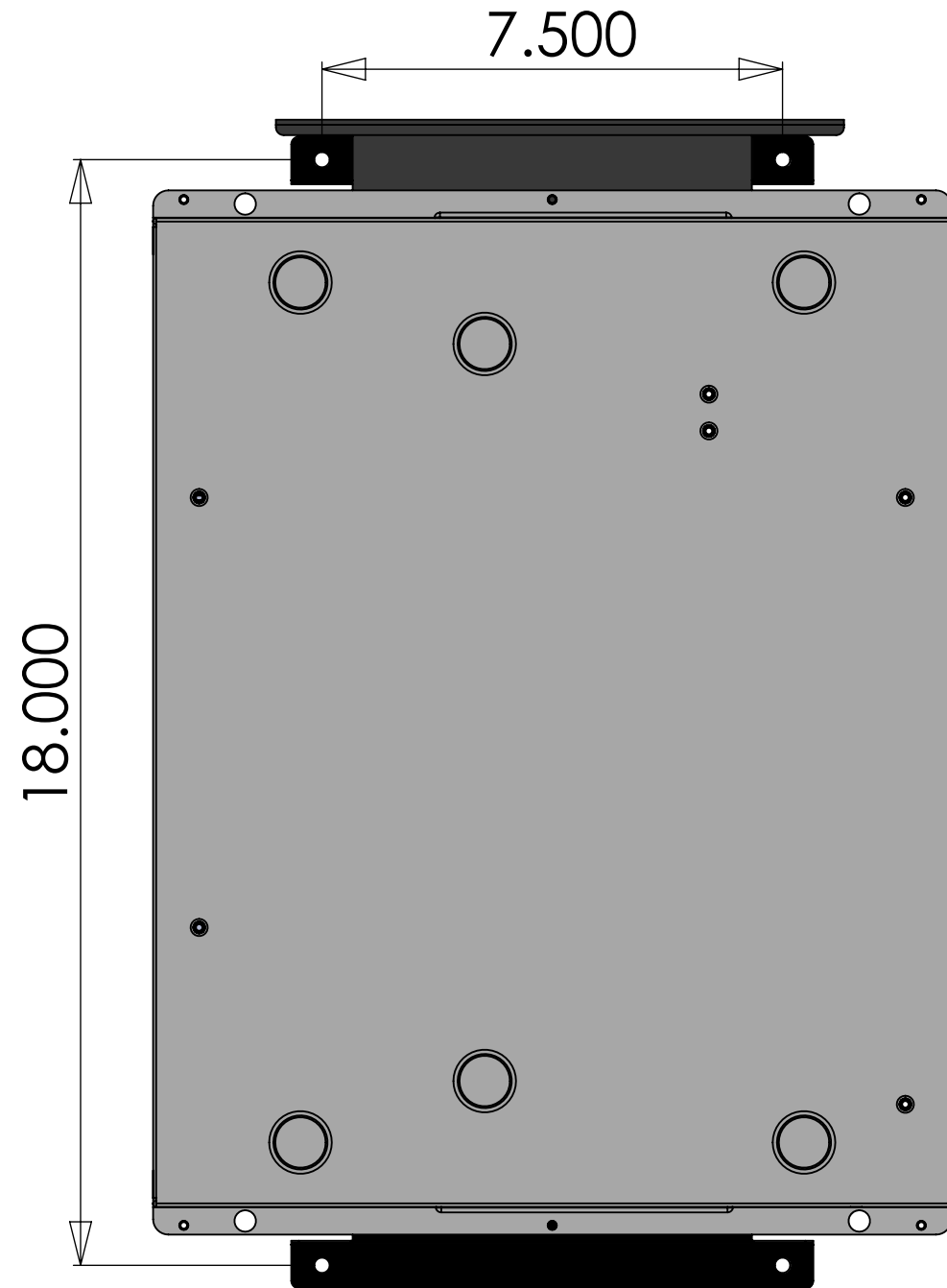

| | | |
|---|--|---------------------|
| DIMENSIONS ARE IN INCHES UNLESS OTHERWISE SPECIFIED TOLERANCES: FRACTIONAL ± 1/64" ANGULAR: BEND ± 0.1% THREE PLACE DECIMAL ± .005" | File Location: C:\Solidworks Working Directory\ | |
| | MATERIAL | 18 Gauge CRS |
| FINISH | Cardinal Black Hammer Epoxy E311-BK04 Semi-Gloss Hammer | |
| DO NOT SCALE DRAWING | | |

| | NAME | DATE |
|---------|-------------|-----------|
| DRAWN | W.Dippenaar | 1/27/2014 |
| CHECKED | S.Johnson | 1/27/2014 |
| REV. | 09 | |

THE INFORMATION CONTAINED IN THIS DRAWING IS THE SOLE PROPERTY OF JOHNSON SYSTEMS INC. ANY REPRODUCTION IN PART OR AS A WHOLE WITHOUT THE WRITTEN PERMISSION OF JOHNSON SYSTEMS INC. IS PROHIBITED.

JOHNSON SYSTEMS INC.
 1923 Highfield Crescent SE.
 Calgary, Alberta
 Canada T2G 5M1
 (403) 287-8003
 (403) 287-9003 Fax



Part # J-PACK DP Complete
 Note: -----

SCALE:1:5

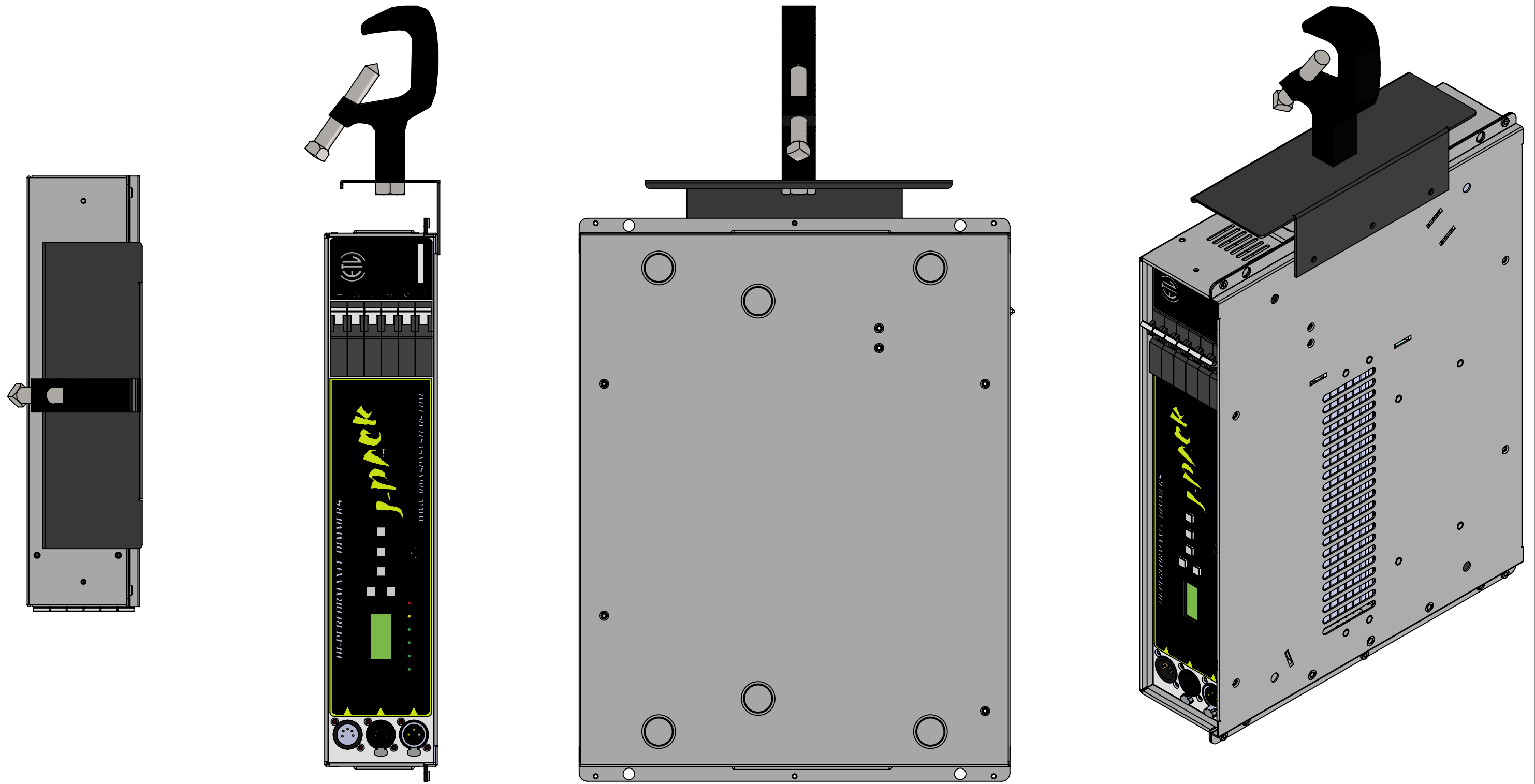

| | | |
|--|---|--|
| DIMENSIONS ARE IN INCHES UNLESS OTHERWISE SPECIFIED TOLERANCES: FRACTIONAL $\pm 1/64"$ ANGULAR: BEND $\pm 0.1\%$ THREE PLACE DECIMAL $\pm .005"$ | File Location: C:\Solidworks Working Directory\ | |
| | MATERIAL 18 Gauge CRS | |
| FINISH Cardinal Black Hammer Epoxy E311-BK04 Semi-Gloss Hammer | | |
| DO NOT SCALE DRAWING | | |

| | NAME | DATE |
|---------|-------------|-----------|
| DRAWN | W.Dippenaar | 1/27/2014 |
| CHECKED | S.Johnson | 1/27/2014 |
| REV. | 09 | |

THE INFORMATION CONTAINED IN THIS DRAWING IS THE SOLE PROPERTY OF JOHNSON SYSTEMS INC. ANY REPRODUCTION IN PART OR AS A WHOLE WITHOUT THE WRITTEN PERMISSION OF JOHNSON SYSTEMS INC. IS PROHIBITED.

JOHNSON SYSTEMS INC.
 1923 Highfield Crescent SE.
 Calgary, Alberta
 Canada T2G 5M1
 (403) 287-8003
 (403) 287-9003 Fax



Part # J-PACK DP Complete
 Note: -----

SCALE:1:5