

# User Manual

# MX-3000+

## Control Retrofit for Electronics Diversified Inc. (EDI) and Cooper MX Series Dimmer Racks

**JOHNSON SYSTEMS INC.**

**www.johnsonsystems.com**



**JOHNSON SYSTEMS INC.**

"PROFESSIONAL LIGHT CONTROL PRODUCTS"

1923 Highfield Crescent S.E.  
Calgary, Alberta, Canada T2G 5M1  
tel: 403.287.8003

fax: 403.287.9003

e-mail: info@johnsonsystems.com

website: www.johnsonsystems.com





## Contents

Warranty .....	2
For Technical Assistance .....	2
Introduction .....	3
Packaging & Contents .....	4
Dimensional Drawings .....	4
Installation .....	5
Control Input/Output Field Wiring Connections .....	7
MX-3000+ Circuit Boards .....	10
EEPROM Memory Module .....	10
User Interface .....	11
LCD Display .....	11
Programming Switches .....	11
System Status • LED Indicators .....	12
System Status • LCD Display .....	12
Quick Programming Reference to System Configuration Menu Items .....	14
Detailed Programming of System Configuration Menu Items .....	15
Important Hard-key Information .....	30
Troubleshooting Reference .....	31

## Warranty

The MX-3000+ retrofit control system comes with a standard two (2) year limited warranty against defects in parts and workmanship. Extended warranties of up to ten (10) years are available at the time of purchase.

For details visit <http://www.johnsonsystems.com/warranties.htm>



**WARNING! WARRANTY VOID** if powered prior to rack modifications as detailed in this manual.

## For Technical Assistance

1. Refer to your product user manual. The most current revision is available online: [www.johnsonsystems.com/literature.htm](http://www.johnsonsystems.com/literature.htm)
2. Contact the "point-of-sale" dealer or distributor from which this product was originally purchased, and ask for technical assistance.
3. If neither of the above can provide you with the necessary information, please contact our factory via email ([info@johnsonsystems.com](mailto:info@johnsonsystems.com)) or phone (403-287-8003) during business hours (Monday to Friday, 8:00AM to 5:00PM MST).



MX-3000+  
(Installed)

## Introduction

The **MX-3000+** is a next generation retrofit electronics package designed specifically for upgrading the EDI/Cooper MX Series performance dimmer racks making system replacement completely unnecessary. This full-featured, state-of-the-art control module provides a direct digital interface to most of today's modern lighting communication protocols. Designed based on the successful 3000 Series control technology developed by JSI, the MX-3000+ shares identical firmware and features as other popular 3000 Series products.



Designed based on the successful 3000 Series control technology developed by Johnson Systems Inc., the MX-3000+ shares identical firmware and features as other popular 3000 Series products.

The MX-3000+ installs in minutes by simply "plugging" into the existing OEM backplane. This compact unit has been designed for OEM rack compatibility, longevity and reliability with the end-user in mind. Intuitive LCD user interface combined with a single modular design makes the MX-3000+ extremely user-friendly and easily serviceable. Advanced next generation hardware and software designs reduce stand-by power consumption to less than 1 Watt, allowing for compliance with the International Energy Agency's "One Watt Initiative" for standby power consumption. MX-3000+ is over 4x more energy efficient than the obsolete OEM electronics!

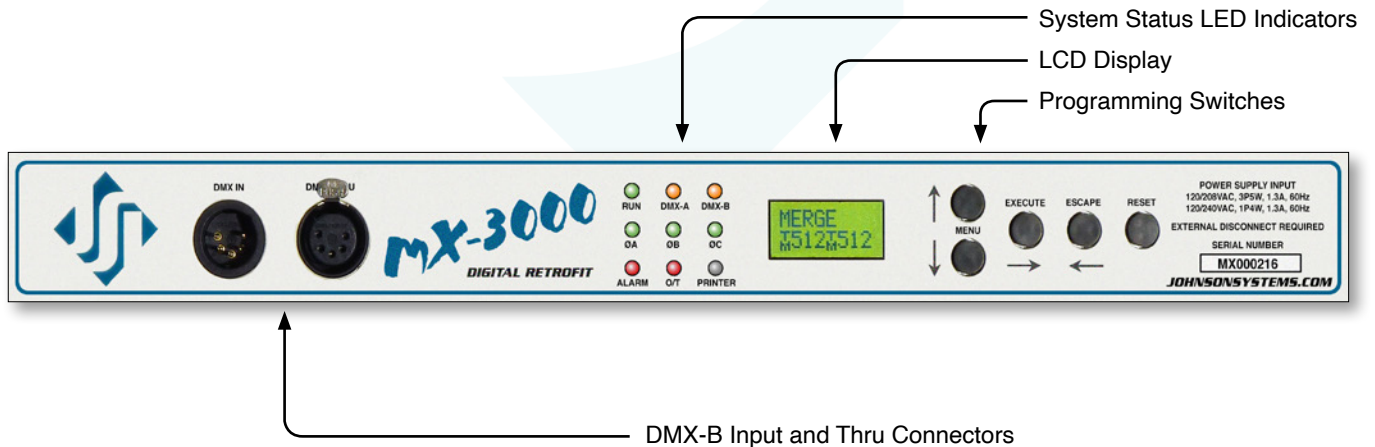



## Packaging & Contents

Each MX-3000+ retrofit control system is shipped in a custom designed box and packaging for protection of the unit. Keep the box and packaging stored in a safe place. In the unlikely event the system needs to be returned to the Johnson Systems Inc. (JSI) factory, the packaging will be required to prevent shipping damage and maintain warranty.

Parts included with the MX-3000+ retrofit control system:

- One (1) MX-3000+ retrofit control module.
- One (1) lexan overlay used to cover over the OEM LCD display.
- Three (3) sticker labels used to relabel the OEM MX INPUT board with three (3) terminal strips.
- Four (4) sticker labels used to relabel the OEM MX INPUT board with four (4) terminal strips.

## Dimensional Drawings

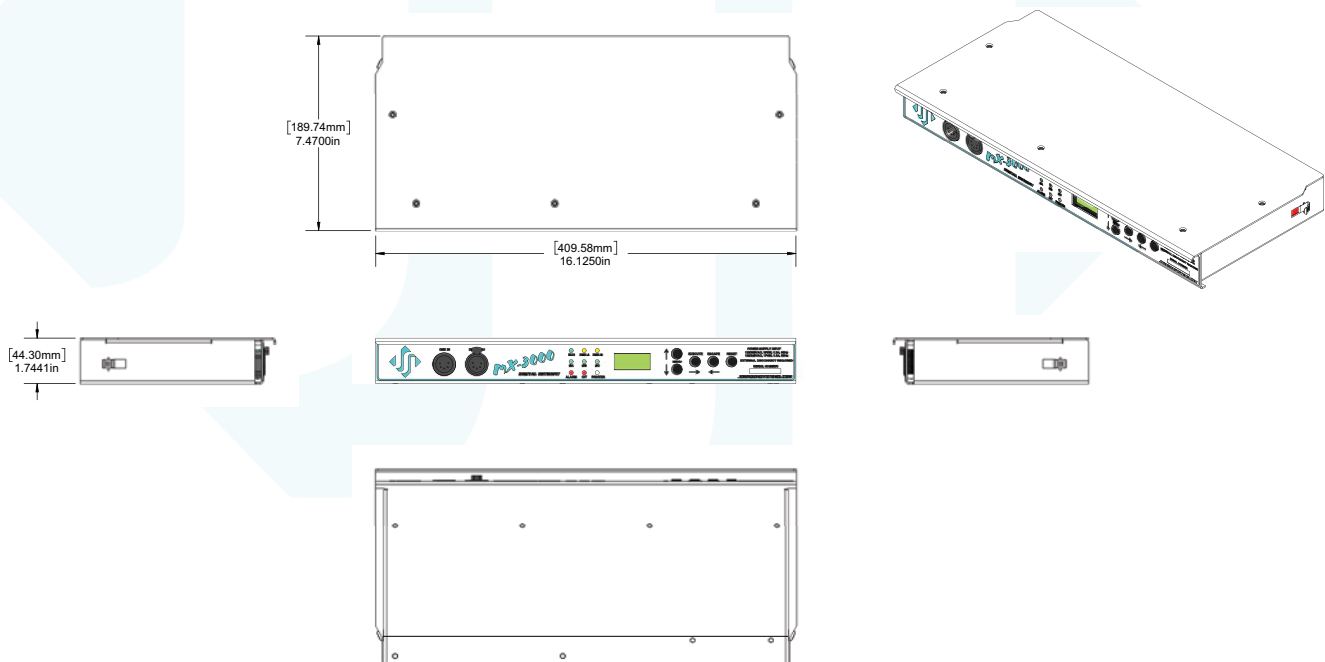

**NOTE:** All measurements are in inches.



## Installation

- Disconnect (turn off) the power supply to the MX dimmer rack(s).



**WARNING!** Risk of electrical shock. Verify all power is disconnected (turned off) before proceeding.

### Removal of the old OEM controller

- Remove old OEM controller.



**NOTE:** To retain \$1,000.00 credit/discount, the old OEM controller must be shipped to the designated location to be recycled within thirty (30) days of invoice date. Further information is in the "RECYCLING CORE CREDIT FORM" provided, or download at [http://www.johnsonsystems.com/mx\\_3000.htm](http://www.johnsonsystems.com/mx_3000.htm).

- Remove the cover panel located above the OEM controller.
- Remove enough dimmer modules to access the field wiring connected to the MX INPUT board, and other electronics and boards located inside the dimmer rack. Be sure to mark the dimmer modules with their slot location, to ensure the dimmer modules are eventually reinstalled into the same slot they were removed from.
- Remove the OEM LCD display cable. Disconnect the cable from the back of the LCD display. Disconnect the cable from P9 on the MX Back Panel board. Cut the cable tie holding the cable.

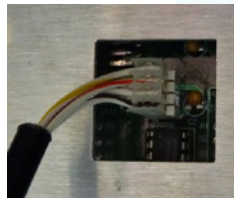

- With the OEM controller and dimmer modules removed, it is a great opportunity to do some preventative maintenance. The dimmer rack should be thoroughly cleaned, vacuumed and sprayed out using compressed air. All connections, including the AC line and load connections, should be inspected and tightened if necessary.
- Inspect the cooling fan and verify it spins freely. Keeping the dimmers cool is very important for longevity. Replacement cooling fans are available. (Model Number: CF-MX) from JSI.
- If you are not familiar with the inside of the MX dimmer rack, it is strongly advised to take a few minutes to inspect the internal OEM wiring. Do not disconnect any other OEM wiring as it must remain intact to complete the retrofit.
- Inspect the field wiring connections coming into the dimmer rack. The field wiring connects to the OEM MX INPUT board and possibly to other boards inside the dimmer rack. Note where all the field wiring is connected and label the cables using a permanent marker (sharpie).
- The MX INPUT board is reused to connect the field wiring to the MX-3000+ retrofit control system. Compare the current field wiring connections to the new field wiring connections required for the retrofit. Refer to the MX INPUT board drawings on page 7 and 8, as well as the Control Input/Output Field Wiring Connections section of this manual, starting on page 7. Do not disconnect any field wiring until you are completely satisfied with how easy this is going to be.
- The only field wiring that remains the same is the DMX input connections.
- Disconnect all other field wiring connections from the MX INPUT board.



### Installation of the new MX-3000+ retrofit control system

- Affix the supplied sticker labels to the OEM MX INPUT board. Labels have been supplied for MX INPUT boards with 3 or 4 terminal strips. Refer to page 7 and 8 for label locations. Be sure the board surface is clean before sticking the labels on.
- Inspect existing DMXA and DMXB input connections. Be sure the wiring complies with standard RS-485 termination practices. If needed, re-terminate the connections. Connect any new DMX required.
- For best results connecting stranded wire, use wire ferules or spade terminals for a #6 size stud.
- Connect all other required field wiring to the MX INPUT board. For further info, refer to the Control Input/Output Field Wiring Connections section of this manual, starting on page 7.
- Clean the glass on the OEM LCD display and affix the cover label supplied.

This rack has been professionally upgraded with state-of-the-art "green" technology that is 4x times more energy efficient than the O.E.M. electronics.



- Reinstall the cover panel located above the controller slot.
- Reinstall all the dimmer modules in the same locations they were removed from.
- Carefully insert the MX-3000+ retrofit control module into the controller slot. Press firmly in and ensure it is completely plugged in and fully seated into the backplane connectors



**WARNING:** Ensure the MX-3000+ retrofit control module chassis is connected to earth ground.

**WARNING:** Risk of electrical shock. Verify all modules and panels are installed before proceeding.

### Turn on and test the new MX-3000+ retrofit control system:

- Connect (turn on) the power supply to the MX dimmer rack(s).
- Verify the operation of the system status LED indicators, LCD display and programming switches.
- Refer to the programming section of this manual for system configuration.
- Test the system thoroughly to ensure all wiring terminations are functioning.
- The DMX IN and DMX THRU XLR connectors located on the front face panel of the MX-3000+ controller, are connected to the DMX-B input internally. The front DMX input XLR connector can not be used simultaneously with the DMX-B input on the internal MX INPUT board, or data collision will occur. Only one of the inputs can be used at a given time.
- Verify all of the dimmer control outputs have the correct phase referencing. If a dimmer control output is patched to the incorrect phase reference, the dimmer will not dim correctly and will go to full output at around 1% DMX input. The factory configuration for MX-3000+ retrofit systems is for three-phase applications, with the dimmer phase reference patch set at AABBBCCAABBCC... The phase patch (Ø-PATCH) menu must be used to configure non-standard applications, or for single-phase applications with the phases 120° out of phase from each other.
- Verify the cooling fan is operating properly. The fan should turn on with between 6-7% DMX or analog control – when DMX or analog control drops below 6-7%, there is a 5 minute timeout on the fan to ensure the dimmers have been cooled sufficiently.



## Control Input/Output Field Wiring Connections

MX-3000+ retrofit control systems come with a variety of control input and output (I/O) capabilities. All I/O connections are terminated on the OEM MX INPUT board located inside the MX dimmer rack.

There are two different types of MX INPUT boards: one with 3 terminal strips (TS1, TS2 and TS3) and one with 4 terminal strips (TS1, TS2, TS3 and TS4). The terminal strips must be re-labeled using the sticker labels supplied. Below are diagrams showing the sticker label locations with all of the I/O field wiring connections.

### OEM MX INPUT Board with 3 Terminal Strips (TS1, TS2, TS3)

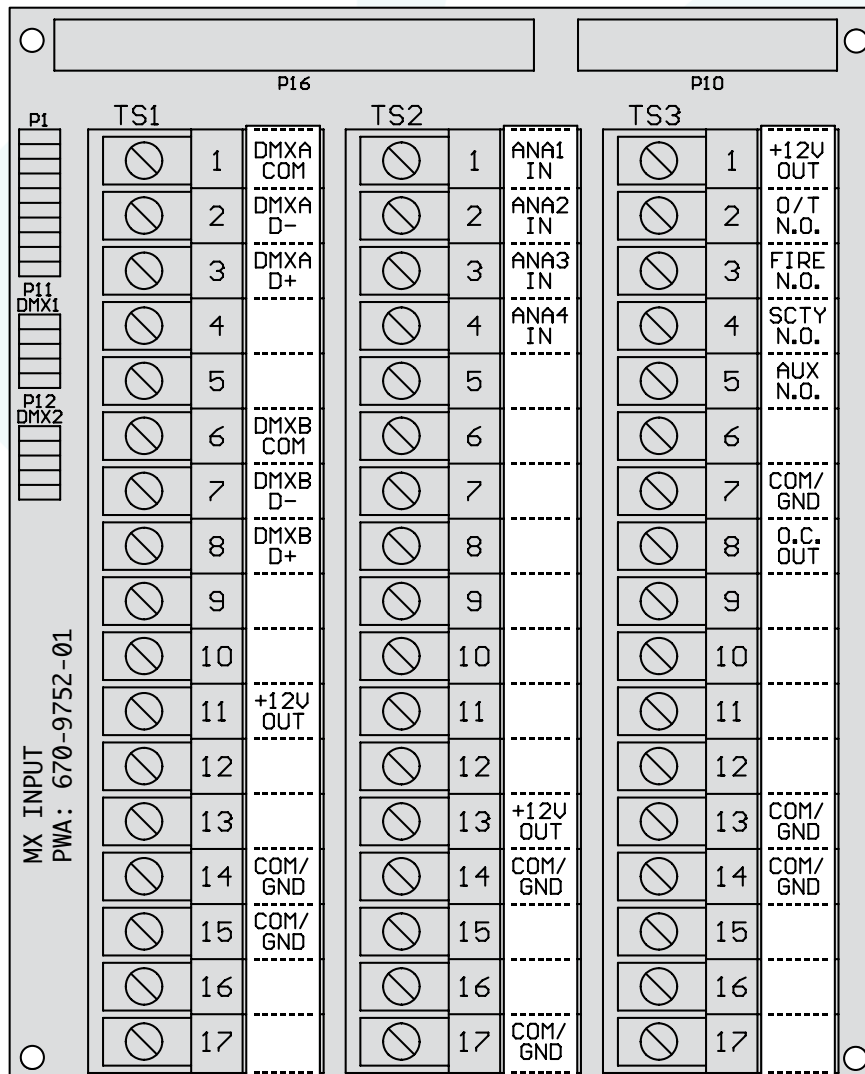

New Sticker Labels



**OEM MX INPUT Board with 4 Terminal Strips (TS1, TS2, TS3, TS4)**

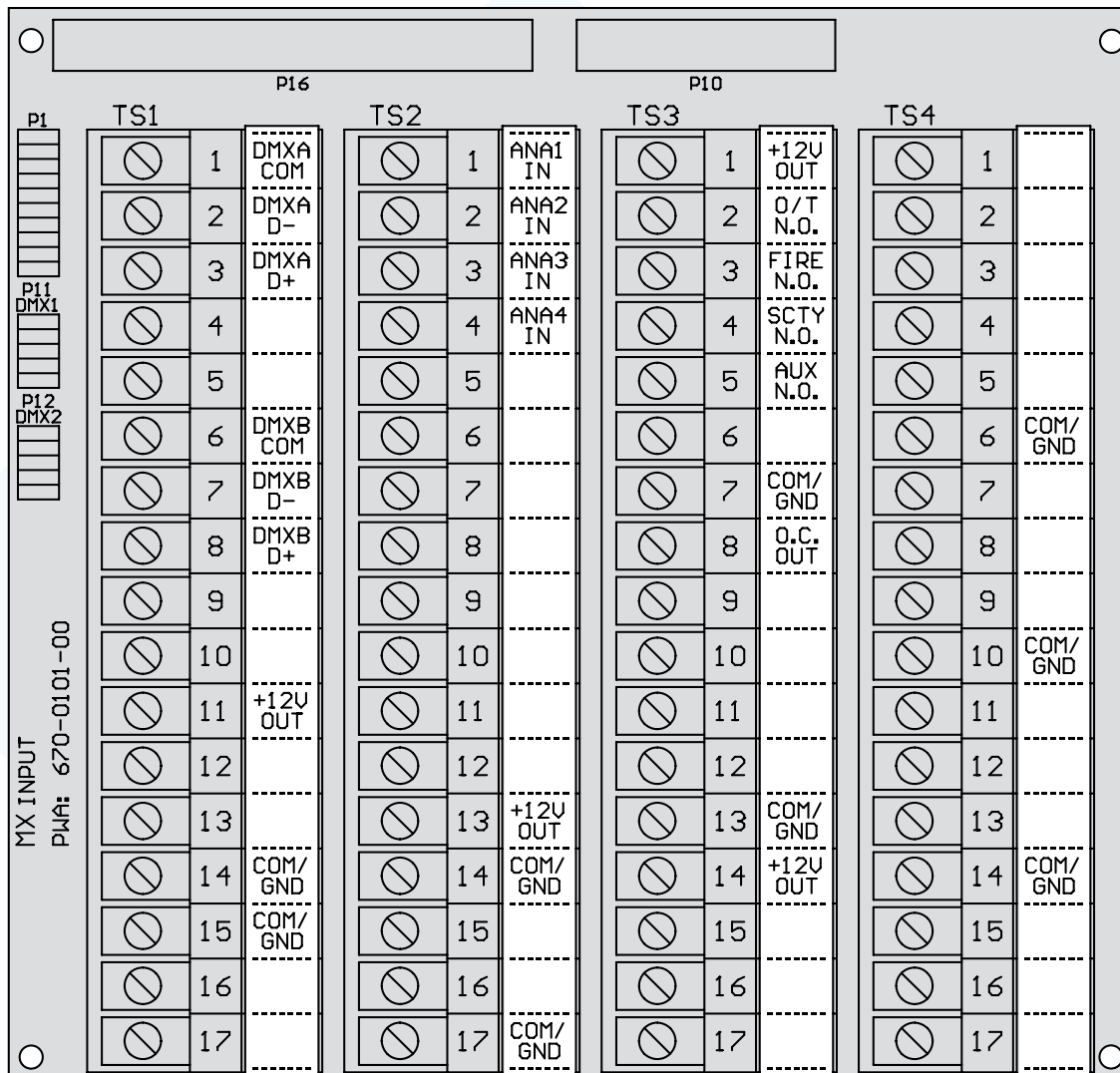

**Isolated Dual DMX Input and Thru**

- DMX-A (DMXA COM, DMXA D-, DMXA D+) input and thru is connected on TS1.
- DMX-B (DMXB COM, DMXB D-, DMXB D+) input and thru is connected on TS1.
- Alternatively, DMX-B input and thru is connected on the 5-pin XLR connectors located on the front face panel of the MX-3000+ controller (XLR pinout: 1=common, 2=data-, 3=data+, 4=thru, 5=thru).
- Complies with USITT DMX512-A (ANSI E1.11 - 2008), standard protocol for digital data control.
- Recommended cable is Belden 9829, 9842, Cat 5 or equivalent (low-capacitance, twisted pair).
- Wiring must follow a daisy-chain topology.
- Maximum of 32 receiving devices on a single DMX line.
- Maximum cable length is 1,500 feet (455 meters).
- For more information, Google DMX, or visit: <http://old.usitt.org/DMX512FAQ.aspx>.

**NOTE:** Ensure only the last (end-of-line) DMX receiving device is terminated!  
Refer to menu items "DMXA TRM" and "DMXB TRM" on page 18 for further details.





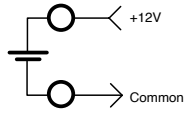

**+12VDC Power Supply Output**

- A regulated +12VDC power supply is available for powering external devices.
- Connect to +12V OUT and COM/GND at multiple locations on the terminal strips.
- External devices should not exceed the maximum combined current draw of 1 Amp.

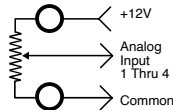

**0-10VDC Analog Inputs or Load Shed Contact Inputs**

- Four (4) analog inputs, ANA1 IN, ANA2 IN, ANA3 IN and ANA4 IN, are connected on TS2.
- Connect the analog low-voltage common reference to COM/GND on the terminal strips.
- Inputs can be configured for normal or load shed mode of operation.
- Inputs can be patched to any combination of dimmer control outputs.
- Programmed in the "ANA MODE" and "ANA PAT" menus. See page 21 and 22 for details.

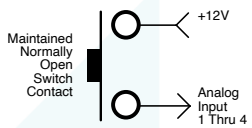

**Over-Temperature Input (Normally Open)**

- Connect to O/T N.O. on TS3.
- Disables all dimmer outputs when the thermostat contact/switch is closed.
- Controlled via a maintained contact/switch to low-voltage common (COM/GND).

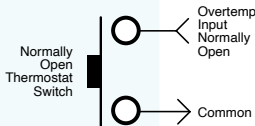

**Fire Alarm Input (Normally Open)**

- Connect to FIRE N.O. on TS3.
- Triggers selected channels to turn on when contact/switch is closed.
- Controlled via a maintained contact/switch to low-voltage common (COM/GND).
- Programmed in the "F-ALARM" menu. See page 24 for details.

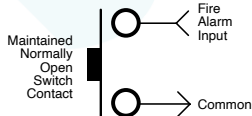

**Security Alarm Input (Normally Open)**

- Connect to SCTY N.O. on TS3.
- Triggers selected channels to cycle on and off at a 1 Hertz rate when contact/switch is closed.
- Controlled via a maintained contact/switch to low-voltage common (COM/GND).
- Programmed in the "S-ALARM" menu. See page 24 for details.

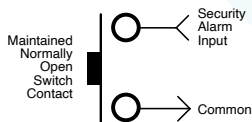

**Auxiliary Input (Normally Open)**

- Connect to AUX N.O. on TS3.
- Triggers 1 of 20 scenes when contact/switch is closed.
- Controlled via a maintained contact/switch to low-voltage common (COM/GND).
- Programmed in the "AUX IN" menu. See page 23 for details.

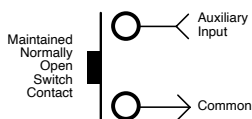

**Open Collector Output**

- Connects to O.C. OUT on TS3.
- Sink up to 100mA.
- Trigger Solid State Relays (SSR) or other external devices.
- Controlled via DMX and/or analog input 4.
- Programmed in the "OC MODE" menu. See page 23 for details.

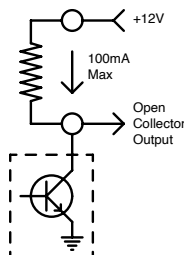



## MX-3000+ Circuit Boards

MX-3000+ retrofit controllers have a central electronic control system (brain), consisting of a circuit board mounted inside the controller chassis. Connected to the main board, is the PWM output daughter board, as well as the user interface board (UIB).

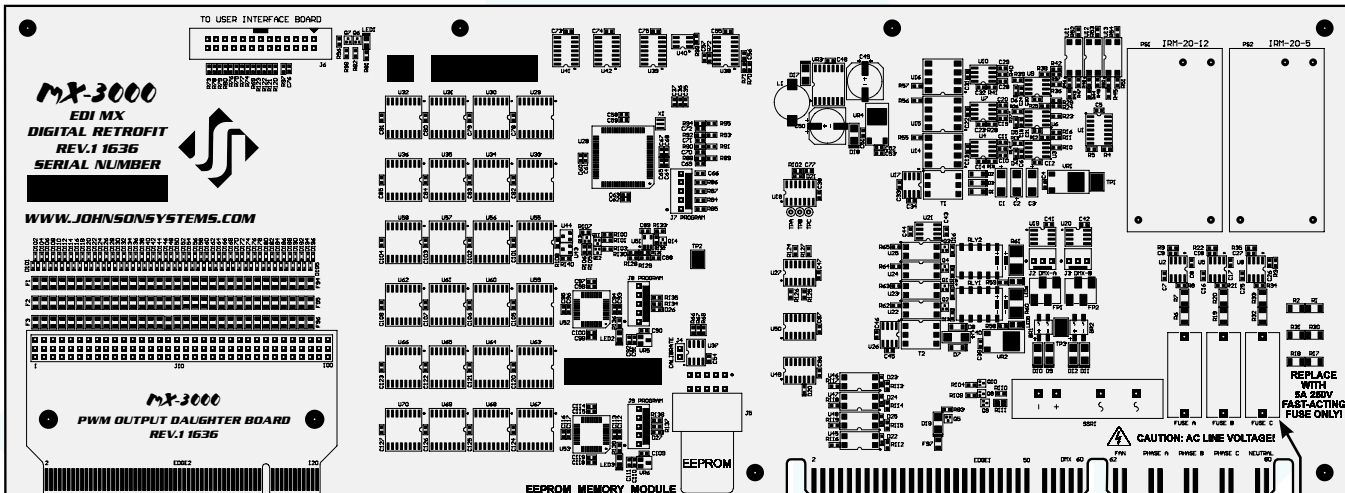

EEPROM Memory Module

AC Line Fuses (3)

Replace the 5A 250V Fast-Acting fuse only!  
The internal power supply and cooling fan are powered from PHASE/FUSE A.



EEPROM  
Memory Module

## EEPROM Memory Module

All MX-3000+ retrofit controllers come equipped with a removable EEPROM memory module. The EEPROM memory module inserts into the on-board connector located at the rear of the MX-3000+ controller chassis. The EEPROM memory module is primarily used to backup important configuration settings, and may be removed for safe storage.

If a firmware update is required, JSI may supply an EEPROM memory module with the latest firmware version. The firmware EEPROM memory module can be inserted into connector, and the firmware can be loaded into the microcontroller.

Refer to menu items "EEPROM", "FW-LOAD", "RESTORE" and "BACKUP" on page 26 to 28 for further details.



**NOTE:** Be sure to "BACKUP" the MX-3000+ controller when installation configuration is complete.

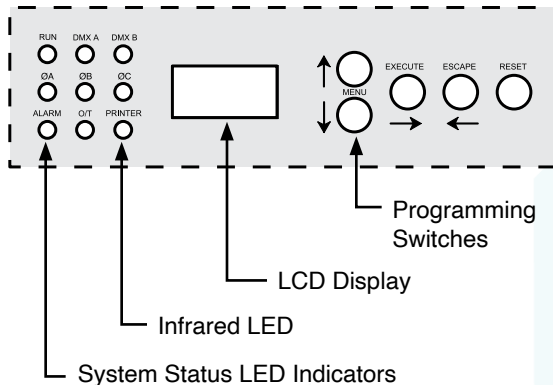

## User Interface

MX-3000+ retrofit control systems are equipped with a user interface. The user interface provides access to all programming and configuration settings. System status is easily visible on the LCD display and LED indicators. An infrared LED allows for printout of all system configuration settings when used with a hand held infrared printer (Johnson System Inc., Part Number: JS-IP).

All of the programming is accomplished using four (4) switches. Within a few minutes most users will find the menu structure very intuitive and easy to navigate. All configuration settings are automatically stored in the on-board EEPROM.

## LCD Display

The LCD display is capable of displaying 2 lines of 8 Characters. A backlight automatically comes on when activity is sensed on the switches. The LCD contrast can be easily adjusted for optimum viewing. Refer to menu item "LCD VIEW" on page 29 for further details.

## Programming Switches

The MENU UP/DOWN (  ) switches are used for navigating through the various system configuration menu items. They also allow for programming of other specific parameters within a selected menu. Pressing and holding either switch will speed up the scroll rate, which can be helpful to speed up the configuration time.

The EXECUTE (  ) switch is normally used to select/enter a menu item, advance forward within a selected menu item, or toggle between parameters within a selected menu item.

The ESCAPE (  ) switch is normally used to back up within a selected menu item one step at a time or exit the menu completely.



**NOTE:** The programming switches can be locked out to prevent inadvertent configuration changes. To toggle between "LOCKED!!" and "UNLOCKED" press and hold down the EXECUTE and then ESCAPE switches at the same time for 4-5 seconds.

The RESET switch has two purposes. First, it allows for quick exit from a menu item after a programming change and automatically puts the system into normal run mode. Second, it provides a soft reboot for the systems microcontroller.



**NOTE:** A detailed procedure for programming all system configuration menu items can be found on page 15 to 29.



## System Status • LED Indicators

---

### **RUN (Green)**

Illuminates when the power is on and the microcontroller status is in normal run mode. The LED flashes once every 2 seconds when the system is in STANDBY mode.

### **ØA, ØB and ØC (Green)**

Illuminates when the line voltage power is within the acceptable range of 100-130 VAC for each phase and the zero-cross reference circuitry is functioning properly. The LED will flash slowly (once per second) when an under-voltage state of less than 100 VAC is sensed and will flash quickly (twice per second) when an over-voltage of greater than 130 VAC is sensed.

### **DMX A and DMX B (Yellow)**

Illuminates when valid DMX is received on each of the inputs. Flashes when invalid DMX is received.

### **ALARM**

Illuminates and flashes twice per second when either a fire or security alarm is sensed on each of the inputs.

### **O/T**

Illuminates and flashes twice per second when the microcontroller senses an internal over-temperature condition, or when an external over-temperature is sensed via the over-temperature input, or when an external dimmer over-temperature is sensed.

## System Status • LCD Display

---

When DMX is being received, the top line of the LCD display shows the active DMX MODE ("PTY A", "PTY B", "MERGE", "DMX A+B", "2 ROOM" or "PATCH"). When DMX is not being received, the top line of the LCD display shows "MX-3000+", unless the system is in standby mode, then "STANDBY!" is displayed.

The bottom line of the LCD Display shows the current status of the system unless the system configuration menu items are being accessed. Below are descriptions for each status indication.

### **NO RX!**

Displayed when DMX is not being received on either input and the system is not in scene mode.

### **AXXXBXXX**

Displayed when valid DMX is being received on one or both inputs and both inputs are not terminated. "A" and "B" represent the DMX A and DMX B inputs while "XXX" represents the number of channels being received in each packet of data. For example, if the system is receiving 512 channels on DMX B and DMX A is disconnected, the display will show "A000B512".

### **$\begin{matrix} T \\ M \end{matrix} XXX \begin{matrix} T \\ M \end{matrix} XXX$**

Same as above except the "A" and "B" is replaced with " $\begin{matrix} T \\ M \end{matrix}$ " to indicate if one or both of the DMX inputs are terminated. For example, if the system is receiving 48 channels on DMX A and 512 channels on DMX B, with only DMX A terminated, the display will show " $\begin{matrix} T \\ M \end{matrix} 048B512$ ". Refer to menu items "DMXA TRM" and "DMXB TRM" on page 18 for further details.

### **SH XX:YY**

Displayed when DMX is disconnected and the systems predetermined DMX status hold (SH) time is counting down. "XX" represents minutes while "YY" represents seconds. Refer to menu item "SH TIME" on page 20 for further details.

**INF HOLD**

Displayed when DMX is disconnected and the systems predetermined DMX status hold (SH) time is set for infinite (INF) hold. Refer to menu item "SH TIME" on page 20 for further details.

**SCENE:XX**

Displays the scene (1 to 20) that is currently activated. The colon in front of the scene number flashed twice per second during fading. Refer to menu item "SCENEMOD" on page 23 for further details.

**A-SCENE!**

Displayed when the auxiliary input is triggered.  
Refer to menu item "AUX IN" on page 23 for further details.

**FIRE!!!**

Displayed when the fire alarm input is triggered.  
Refer to menu item "F-ALARM" on page 24 for further details.

**SECURITY**

Displayed when the security alarm input is triggered.  
Refer to menu item "S-ALARM" on page 24 for further details.

**DIM-TEMP**

Displayed when an external dimmer over-temperature is sensed via a dimmer module. The effected dimmer module is disabled until the dimmer module temperature drops to within specification.

**EXT-TEMP**

Displayed when an external over-temperature is sensed via the over-temperature input. All dimmer outputs are disabled and the fans are turned on to full until the external devices temperature drops to within specification. See "Over-Temperature Input" information on page 9 for further details.

**CTL-TEMP**

Displayed when the microcontroller senses an internal over-temperature condition of 185°F (85°C) or more. All dimmer outputs are disabled and the fans are turned on to full until the temperature cools down to 178°F (81°C) or less. See menu item "CTL TEMP" to view the current microcontroller temperature.

**Ø ERROR!**

Displayed when an error is sensed on any of the input power phases. A phase error can be caused from an under-voltage of less than 100VAC, an over-voltage of greater than 130VAC, or if a zero-cross phase reference is not detected.

**RTC ERR!**

Displayed when the system detects a runtime counter (RTC) error. This occurs when there is an invalid hard-key code and the runtime counter is greater than 2160 hours (90 days). Refer to menu item "HARD-KEY" on page 26 for further details.

**LOCKED!!**

Displayed when an attempt is made to access the system configuration menu items and the programming switches are locked out. To toggle between "LOCKED!!" and "UNLOCKED" press and hold down the "EXECUTE" and then "ESCAPE" switches at the same time for 4-5 seconds.



## Quick Programming Reference to System Configuration Menu Items

---

1. **SCENESET** Enable and setup 20 different backup scenes.
2. **FADETIME** Set the fade time for each of the 20 scenes from 0 to 99 seconds.
3. **SNAPSHOT** Record DMX levels into the backup scenes.
4. **DIM TEST** Test the dimmer outputs one at a time, or all at once.
5. **MONITOR** View the control level to each dimmer output.
6. **ADDRESS** Set the DMX start address.
7. **DMX MODE** Configure the mode of the on-board DMX protocol manager.
8. **2 RM SET** Set the two room assignment for each of the dimmer outputs.
9. **DMXA TRM** Enable or disable termination on the DMX A input.
10. **DMXB TRM** Enable or disable termination on the DMX B input.
11. **DMX O/P** Configure the on-board DMX protocol manager for offset or patch mode.
12. **DMXA PAT** Patch the 96 dimmer (PWM) outputs to any DMX A input channel.
13. **DMXB PAT** Patch the 96 dimmer (PWM) outputs to any DMX B input channel.
14. **SH TIME** Set the DMX status hold time from 0 to 99 minutes or infinite.
15. **DC PATCH** Configure the dimmer to channel patch for the dimmer rack.
16. **DIM CURV** Configure the dimmer curve for each output.
17. **ND-LEVEL** Set the non-dim trigger level threshold for each output.
18. **VOUT LIM** Set the maximum RMS output voltage for each dimmer.
19. **REGULATE** Enable or disable the dimmer output voltage regulation.
20. **ANA MODE** Configure the analog inputs for normal or load shed mode.
21. **ANA PAT** Patch the analog inputs to any combination of control channels.
22. **ANA TEST** View the control level for each of the analog inputs.
23. **ANA FLTR** Apply a noise filter on the analog inputs of up to 1 Volt.
24. **ANA BLOC** Enable or disable the analog inputs when DMX is being received.
25. **STANDBY** Enable or disable the power savings standby mode.
26. **TEST INC** Set the test increment units to percent or hexadecimal.
27. **OC MODE** Configure the input trigger parameters for the open collector output.
28. **AUX IN** Select which scene the auxiliary input will trigger/enable.
29. **SCENEMOD** Enable or disable scene mode and the auxiliary input.
30. **S-ALARM** Select the level and control channels triggered by the security alarm input.
31. **F-ALARM** Select the level and control channels triggered by the fire alarm input.
32. **Ø-PATCH** Set the zero-cross phase reference for each dimmer control output circuit.
33. **WARMING** Turn the "lamp warming" feature on or off.
34. **LINE V** View the RMS line voltage for each power phase.
35. **LINE F** View the line frequency of phase A.
36. **CTL TEMP** View the temperature of the microcontroller.
37. **RTIME** View the total run time of the microcontroller.
38. **HARD-KEY** View the microcontroller's unique six-character hard-key code.
39. **SERIAL#** View the microcontroller's unique six-character silicone serial number.
40. **VERSION** View the microcontroller's firmware version.
41. **EEPROM** View the type of EEPROM memory module plugged in.
42. **FW-LOAD** Load new firmware into the MX-3000+ via the EEPROM memory module.
43. **RESTORE** Restore parameters saved in the EEPROM memory module.
44. **BACKUP** Backup parameters and save them in the EEPROM memory module.
44. **PRINTOUT** Print various system configuration settings using a hand held infrared printer.
46. **DEFAULTS** Set various system configuration settings to the factory default.
47. **LCD VIEW** Adjust the contrast of the LCD Display for optimum viewing.



## Detailed Programming of System Configuration Menu Items



**NOTE:** The programming switches can be locked out to prevent inadvertent configuration changes. To toggle between "LOCKED!!" and "UNLOCKED" press and hold down the EXECUTE and then ESCAPE switches at the same time for 4-5 seconds.

The sequence of the following system configuration menu items appear as the MENU DOWN ( ↓ ) switch is pressed. Pressing the MENU UP ( ↑ ) switch will sequence the system configuration menu items in the opposite order. Pressing and holding either of the MENU UP/DOWN ( ⬆ ) switches will speed up the scroll rate, which can be helpful to speed up the configuration time.

### 1. SCENESET

*Enable and setup 20 different backup scenes.*

When scene mode is activated the selected scene will be held with no timeout until the menu is exited. The 96 control channel levels are configured within the menu and can be modified on the fly. Scene mode is useful when an external controller is not available and independent internal control is required.

Press EXECUTE to enter the menu and activate scene mode.

SCENE>01

Displays the scene (01) to be activated.

SCENE>20

Press MENU ( ⬆ ) to select a different scene from 01 to 20.

CTRL: ON

Control (CTRL) is ON via the selected scene.

CTRL:DMX

Control (CTRL) is via DMX and takes priority over scene mode.

CTRL:HLD

Control (CTRL) is via DMX status hold (HLD) and takes priority over scene mode.

SCENE>20

Press EXECUTE to activate the selected scene.

SCENE:20

The colon (:) flashes twice per second while fading to the selected scene.

SCENE:20

The colon (:) stops flashing when fade is complete and the selected scene is active.

SCENE>20

Press MENU ( ⬆ ) to select a different scene from 01 to 20.

SCENE 20

Press EXECUTE to modify the selected scene.

C>01L 00

The second line on the LCD indicates the control channel (C) and level (L).

C>96L 00

Press MENU ( ⬆ ) to select the control channel (C) to modify from 01 to 96.

C 96L>00

Press EXECUTE to toggle from channel (C>) to level (L>) selection.

C>96L 00

Press ESCAPE to toggle from level (L>) to channel (C>) selection.

C 96L>FL

Press MENU ( ⬆ ) to select the output level (L) for the selected channel from 00 to FL.

CLEAR???

Press EXECUTE to clear the selected preset, and set all channels to 00 level.

SURE ???

Press EXECUTE if you are sure to clear the selected preset.

DONE !!!

Indicates the selected preset has been cleared.

WAIT...

Press ESCAPE to exit and the menu and save programmed scene levels.

Press ESCAPE to back-up within the menu, or exit/deactivate scene mode.

Press RESET to exit scene mode without saving programmed scene levels.



**NOTE:** When scene mode is activated: DMX and DMX status hold (SH TIME) automatically takes precedence over scene mode. The analog input levels are merged (HTP) with the scene levels. If the analog inputs are configured for load shed mode the inputs will take precedence over the active scene. The security alarm (S-ALARM) input is merged (HTP) with the scene levels while the fire alarm (F-ALARM) input automatically takes precedence. Scene mode (SCENEMOD) and the auxiliary input (AUX IN) are temporarily enabled. Scene mode will only activate dimmers assigned to room "A".

### 2. FADETIME

*Set the fade time for each of the 20 scenes from 0 to 99 seconds.*

The factory default is 5 seconds for all 20 presets.

Press EXECUTE to enter the menu.

S>01T 05

Displays the scene (S>01) and assigned fade time (T 05).

S>20T 05

Press MENU ( ⬆ ) to select a different scene from 01 to 20.

S 20T>05

Press EXECUTE to toggle between scene (S>) and fade time (T>) selection.

S 20T>99

Press MENU ( ⬆ ) to select a different fade time from 00 to 99 seconds.

Press ESCAPE to exit the menu and save the selected fade time.

Press RESET to exit the menu without saving.

The menu will automatically timeout after 5 minutes of inactivity and save.



**3. SNAPSHOT**

*Record DMX levels into the backup scenes.*

Provides a quick and easy way to save control channel levels into each of the 01 to 20 backup scenes using a DMX source.

Press EXECUTE to enter the menu and activate snapshot mode.

SAVE >01  
SCENE>20  
SURE ???  
DONE !!!  
NO RX!

Press MENU (  ) to select a different scene from 01 to 20.

Press EXECUTE to store DMX levels in the selected scene.

Press EXECUTE if you are sure the DMX levels are set as intended.

DMX levels have now been stored in the selected scene.

DMX is not being received on either input, so a snapshot is not possible.

Press ESCAPE to back-up within the menu, or exit/deactivate snapshot mode.

Press RESET to exit/deactivate snapshot mode.

**4. DIM TEST**

*Test the dimmer outputs one at a time, or all at once.*

A technician's best friend! Used for troubleshooting the dimmer outputs and field wiring to the load.

Press EXECUTE to enter the menu and activate dimmer test mode.

D 01L>00  
D 01L>50  
D 01L>FL  
D>01L FL  
D>ALL FL

Displays the active dimmer (D) and the test level (L).

Press MENU (  ) to select the desired test level.

Press ESCAPE to toggle the test level from full-on (FL) and off (00).

Press EXECUTE to toggle between the dimmer (D>) and the test level (L>).

Press MENU (  ) to select the active dimmer from 01 to 96 or ALL.

Press ESCAPE or RESET to exit the menu.

The menu will automatically timeout after 5 minutes of inactivity.

**5. MONITOR**

*View the control level to each dimmer output.*

The dimmer control level is displayed as a 9-bit value from 000 to 512. This menu does not timeout automatically and will continue to monitor indefinitely.

Press EXECUTE to enter the menu and activate monitor mode.

D>01L000  
D>96L512

Press MENU (  ) to select the dimmer (D) output to monitor from 01 to 96.

Display shows dimmer 96 has full-on control.

Press ESCAPE or RESET to exit the menu.



**NOTE:** The control value will not reach 512 when voltage output limiting is activated, or when regulation is enabled and the line voltage is greater than 118 VAC.

**6. ADDRESS**

*Set the DMX start address.*

The DMX start address can be assigned from 001 to 512 and is common to both DMX inputs.

When DMX MODE is set for DMX A+B operation, each of the DMX inputs can be assigned to a separate DMX start address. The DMX inputs are merged and DMX-B is offset by the number of DMX-A channels.

Press EXECUTE to enter the menu.

DMXA>001  
DMXA>512  
DMXA>001  
DMXA>025  
DMXB>001  
DMXB>512  
#CHA=>01  
#CHA=>96

Displays the current DMX start address for both DMX inputs.

Press MENU (  ) to modify and select the desired DMX start address.

Press both MENU (  ) simultaneously to toggle to DMX start address 001.

Press EXECUTE to save the selected DMX start address.

\* Press EXECUTE to advance to select the DMX-B start address.

\* Press MENU (  ) to modify and select the desired DMX start address.

\* Press EXECUTE to advance to select the number of DMX-A channels.

\* Press MENU (  ) to modify the number of DMX-A channels from 01 to 96.

Press ESCAPE to exit the menu and save the selected DMX start address.

Press RESET to exit the menu without saving.

The menu will automatically timeout after 5 minutes of inactivity and save.



**NOTE:** \* DMX MODE must be set for DMX A+B operation to access this feature.

**NOTE:** DMX O/P must be set to OFFSET mode for this menu to function.





**7. DMX MODE**

*Configure the mode of the on-board DMX protocol manager.*

There are five different mode settings for the DMX protocol manager.

Priority A (PTY A) and Priority B (PTY B) modes are intended for the implementation of a backup DMX source. Priority A (PTY A) sets the DMX A input as the priority, and ignores the DMX B input when the DMX A input is active. Priority B (PTY B) sets the DMX B input as the priority, and ignores the DMX A input when the DMX B input is active.

Merge (MERGE) mode combines both DMX inputs with highest-takes-precedence (HTP) operation. Merge mode allows for simultaneous DMX control of the dimmers from both inputs, and is the default for the system.

Dual Universe DMX (DMX A+B) mode provides a method to combine two universes of DMX within one system. It permits two independent DMX sources to be active on the DMX inputs, with each having a separate DMX start address. The DMX inputs are merged and DMX-B is offset by the number of DMX-A channels programmed via the ADDRESS menu (see page 16 for further details). This feature is typically used when a system is at the end of one DMX universe (DMX-A) and the beginning of another (DMX-B).

Two Room (2 ROOM) mode enables the room (A or B) assignment for each of the dimmer outputs via the 2 RM SET menu.

PTY A

Press EXECUTE to toggle into Priority A (PTY A) mode.

PTY B

Press EXECUTE to toggle into Priority B (PTY B) mode.

MERGE

Press EXECUTE to toggle into Merge (MERGE) mode.

DMX A+B

Press EXECUTE to toggle into Dual Universe DMX (DMX A+B) mode.

2 ROOM

Press EXECUTE to toggle into Two Room (2 ROOM) mode.

Press ESCAPE or RESET to exit the menu.

Any change in the configuration is automatically saved.



**NOTE:** DMX O/P must be set to OFFSET mode for this menu to function.

**8. 2 RM SET**

*Set the two room assignment for each of the dimmer outputs.*

This menu is used to assign each of the 96 dimmer outputs to room "A" or room "B". Dimmer outputs assigned to room "A" are controlled via the DMX-A input. Dimmer outputs assigned to room "B" are controlled via the DMX-B input. This creates separation within the dimmer rack and makes a single dimmer rack function as though it is two independent dimmer racks. When used in conjunction with the DC PATCH menu, the dimmer rack can be configured for sequential DMX control of two rooms, even if the dimmer room assignments are not sequential.

DMX MODE must be set for 2 ROOM operation for this menu to function.

Press EXECUTE to enter the menu and activate 2 RM SET mode.

DIM 01 A

Displays the dimmer (DIM) output (01) and the room assignment (A).

DIM 96 A

Press MENU (  ) to select a different dimmer output from 01 to 96.

DIM 96 B

Press EXECUTE to toggle the room assignment from A to B.

Press ESCAPE or RESET to exit the menu.

Any change in the configuration is automatically saved.



**NOTE:** Scene mode (SCENESET) will only activate/control dimmers assigned to room "A".

**NOTE:** DMX O/P must be set to OFFSET mode for this menu to function.



**9. DMXA TRM**

*Enable or disable termination on the DMX A input.*

Activates and deactivates a 120Ω termination resistor. DMX termination is indicated on the LCD display when DMX is being received. When the DMX A input is not terminated (DISABLED) the LCD display will read AXXXBXXX. When the DMX A input is terminated (ENABLED) the LCD display will read  $\bar{1}$ XXXBXXX.

ENABLED

Press EXECUTE to toggle termination from ENABLED to DISABLED.

DISABLED

Press EXECUTE to toggle termination from DISABLED to ENABLED.

Any change in the configuration is automatically saved.



**NOTE:** Ensure **only** the last (end-of-line) DMX receiving device is terminated!

**10. DMXB TRM**

*Enable or disable termination on the DMX B input.*

Activates and deactivates a 120Ω termination resistor. DMX termination is indicated on the LCD display when DMX is being received. When the DMX B input is not terminated (DISABLED) the LCD display will read AXXXBXXX. When the DMX B input is terminated (ENABLED) the LCD display will read AXXX $\bar{1}$ XXX.

ENABLED

Press EXECUTE to toggle termination from ENABLED to DISABLED.

DISABLED

Press EXECUTE to toggle termination from DISABLED to ENABLED.

Any change in the configuration is automatically saved.



**NOTE:** Ensure **only** the last (end-of-line) DMX receiving device is terminated!

**11. DMX O/P**

*Configure the on-board DMX protocol manager for offset or patch mode.*

OFFSET mode is typically used for the majority of systems, and is the factory default. OFFSET mode refers to the DMX start address, with each of the 96 dimmer (PWM) outputs addressed sequentially from the DMX start address.

PATCH mode provides full flexibility for addressing each of the 96 dimmer (PWM) outputs. Each of the 96 dimmer (PWM) outputs can be patched to (controlled from) any DMX input channel from 001 to 512, from either or both of the DMX A and DMX B inputs simultaneously

With DMX patch mode activated, any configuration within the ADDRESS, DMX MODE, 2 RM SET and DC PATCH menus is ignored, and the DMX patch configured within the DMXA PAT and DMXB PAT menus takes precedence.

When using the system in DMX patch mode, it is strongly recommended to printout the patch using a hand held infrared printer (Johnson System Inc., Part Number: JS-IP). Press EXECUTE to enter the menu and configure the DMX mode.

DISABLED

This menu is disabled to help prevent inadvertent changes. Proceed to enable.

ENABLED

Press and hold MENU ( ↓ ) and MENU ( ↑ ) at the same time for 4-5 seconds.

OFFSET

Press EXECUTE to toggle the DMX mode from OFFSET to PATCH.

PATCH

Press EXECUTE to toggle the DMX mode from PATCH to OFFSET.

Press ESCAPE or RESET to exit the menu.

Any change in the configuration is automatically saved.

**12. DMXA PAT**

*Patch the 96 dimmer (PWM) outputs to any DMX A input channel.*

There are two ways to configure the DMX patch. Each of the 96 dimmer (PWM) outputs can be manually (MANUAL) patched to a DMX input channel, or patched in blocks (BLOCK) of sequential dimmers and DMX channels.

For MANUAL patching, each of the dimmers are patched individually. First, the dimmer (DIM) output is selected, and then any DMX input channel from 001 to 512 is patched to the selected dimmer.

For BLOCK patching, a sequential range of dimmers are patched to a sequential range of DMX channels. First, the first dimmer number (DIM#) in the block is selected, then the DMX A start address (DMXA) for the block is selected, and then finally the number of dimmers (#DIM) in the block is selected. For example, if DIM# is 001, DMX is 001, and #DIM is 096, then all of the dimmer outputs, 001 thru 096 are addressed sequentially to DMX channels 001 thru 096.



For a more complex example, if DIM# is 049, DMX is 321, and #DIM is 024, then dimmer outputs 049 thru 073 are addressed sequentially to DMX channels 321 thru 344. Using a combination of MANUAL and BLOCK patching methods can speed up configuration. Typically, a BLOCK of dimmers is first patched and then edited using the MANUAL patch.

The DMX patch should be cleared (CLEAR) before configuring the patch. Clearing the patch ensures all previously configured patch data is cleared (erased). When DMXA PAT is utilized in conjunction with DMXB PAT, each of the 96 dimmer (PWM) outputs can be patched to (controlled from) any DMX input channel from 001 to 512, from either or both of the DMX A and DMX B inputs simultaneously. If a dimmer is patched to both DMX A and DMX B input channels, the DMX levels are merged and highest-takes-precedence (HTP).

Press EXECUTE to enter the menu and configure the DMX A patch.

Press MENU (  $\blacktriangledown$  ) to scroll through and select the patching method.

Press EXECUTE to patch each of the dimmers manually (MANUAL).

The top line shows the dimmer (DIM) and (DMXA) address headings.

The second line shows the dimmer (DIM) and (DMXA) address values.

Press MENU (  $\blacktriangledown$  ) to select the dimmer (DIM) from 001 to 096 to patch.

Press MENU (  $\blacktriangle$  ) and MENU (  $\blacktriangledown$  ) at the same time to toggle back to 001.

Press EXECUTE to advance and select the DMXA address for the dimmer.

DMXA is initialized at 999 to indicate the dimmer is not patched.

? indicates the DMXA address (513 to 999) is invalid and is not patched.

The cursor (  $\_$  ) position indicates the DMXA digit to be edited.

Press EXECUTE to move the cursor to the right, under the digit to be edited.

Press ESCAPE to move the cursor to the left or to exit the menu.

Press MENU (  $\blacktriangle$  ) to select the DMXA address from 001 to 512.

Press MENU (  $\blacktriangle$  ) and MENU (  $\blacktriangledown$  ) at the same time to toggle back to 999.

Repeat until all required dimmers are manually patched.

Press EXECUTE to patch the dimmers in a sequential block (BLOCK).

Press EXECUTE to select the first dimmer number (DIM#) in the block.

Press MENU (  $\blacktriangle$  ) to edit the dimmer number (DIM#) from 001 to 096.

Press MENU (  $\blacktriangle$  ) and MENU (  $\blacktriangledown$  ) at the same time to toggle back to 001.

Press EXECUTE to select the DMX A (DMXA) start address for the block.

Press MENU (  $\blacktriangle$  ) to edit the DMX A (DMXA) start address from 001 to 512.

Press MENU (  $\blacktriangle$  ) and MENU (  $\blacktriangledown$  ) at the same time to toggle back to 001.

Press EXECUTE to select the number of dimmers (#DIM) in the block.

Press MENU (  $\blacktriangle$  ) to edit the number of dimmers (#DIM) from 001 to 096.

Press MENU (  $\blacktriangle$  ) and MENU (  $\blacktriangledown$  ) at the same time to toggle back to 001.

Press EXECUTE to proceed.

Press EXECUTE to proceed.

Indicates the sequential block patch has been completed.

Repeat until all required blocks of sequential dimmers have been patched.

Press ESCAPE to exit the menu.

Press EXECUTE to clear the entire patch.

Press EXECUTE to proceed.

Indicates the entire patch has been cleared.

Press ESCAPE to exit the menu and save the selected patch.

Press RESET to exit the menu without saving.

The menu will automatically timeout after 5 minutes of inactivity and save.

MANUAL?  
DIM DMXA  
001<999?  
096<999?  
001<999?  
001 999?  
001 999?  
001 999?  
001 999?  
001 999?  
001 999?  
001 512  
001 999?

BLOCK?  
DIM#:001  
DIM#:096  
DIM#:001  
DMXA:001  
DMXA:512  
DMXA:001  
#DIM:001  
#DIM:096  
#DIM:001  
PROCEED?  
SURE ???  
DONE !!!

CLEAR???  
SURE ???  
DONE !!!



**NOTE:** Be sure to BACKUP any configuration changes!

**NOTE:** With DMX patch mode activated, any configuration within the ADDRESS, DMX MODE, 2 RM SET and DC PATCH menus is ignored, and the DMX patch configured within this menu takes precedence.



**13. DMXB PAT**

*Patch the 96 dimmer (PWM) outputs to any DMX B input channel.*

Refer to the DMXA PAT menu for further information.

The DMXA PAT menu is used to patch dimmers to DMX A input channels, while the DMXB PAT menu is used to patch dimmers to DMX B input channels.

**14. SH TIME**

*Set the DMX status hold time from 0 to 99 minutes or infinite.*

When DMX is disconnected the system will hold the status of the last received DMX levels for the selected amount of time. When activated, the LCD display shows a countdown of the status hold time or infinite hold.

Press EXECUTE to enter the menu.

HTIME 00  
HTIME 99  
HTIME XX  
HTIME 00

Displays the current DMX status hold time (HTIME) setting.

Press MENU (  ) to set the desired hold time from 00 to 99 minutes.

Press MENU (  ) to set the desired hold time to infinite (XX).

Press both MENU (  ) switches to toggle back to status hold time of 00.

Press ESCAPE to exit the menu and save the desired DMX status hold time.

Press RESET to exit the menu without saving.

The menu will automatically timeout after 5 minutes of inactivity and save.

**15. DC PATCH**

*Configure the dimmer to channel patch for the dimmer rack.*

Each of the 96 dimmer (PWM) outputs can be assigned and patched to any of the 96 control channels. Multiple dimmer outputs may be patched to a single control channel. The dimmer to channel patch is used by other menu features to provide transparent control of the dimmer output circuits. MX-3000+ systems are typically patched for 1 to 1 operation but may be altered for custom applications.

Press EXECUTE to enter the menu.

D01<C01  
D96<C96  
D96 C96<  
D96 C01<  
D96<C01

Displays the dimmer (D) output (01) and its current control channel (C) patch (01).

Press MENU (  ) to select the desired dimmer output from 01 to 96.

Press EXECUTE to toggle the pointer (<) to select the control channel to patch.

Press MENU (  ) to select the desired control channel from 01 to 96.

Press EXECUTE to toggle the pointer (<) to select another dimmer output.

Press ESCAPE to exit the menu and save the desired dimmer channel patch.

Press RESET to exit the menu without saving.

The menu will automatically timeout after 5 minutes of inactivity and save.



**NOTE:** DMX O/P must be set to OFFSET mode for this menu to function.

**16. DIM CURV**

*Configure the dimmer curve for each output.*

There are four different dimmer curve profiles that can be assigned to each individual dimmer output circuit. Square Law (SQ) curve is the industry standard and the default for all dimmers. Linear (LN) curve modifies the dimmer output for a linear relationship to the control input level. Direct Drive (DD) curve is not modified - meaning the control input level is directly proportional to the control output level. Non-Dim (ND) curve assigns the dimmer circuit to operate in a full-on or off state only, with no dimming. Dimmers set for non-dim (ND) will be triggered full-on at the ND-LEVEL setting.

Press EXECUTE to enter the menu.

DIM01 SQ  
DIM96 SQ  
DIM96 LN  
DIM96 DD  
DIM96 ND

Displays the dimmer (DIM) output (01) and its current dimmer curve.

Press MENU (  ) to select the desired dimmer number from 01 to 96.

Press EXECUTE to toggle to linear (LN) curve mode.

Press EXECUTE to toggle to direct drive (DD) mode.

Press EXECUTE to toggle to non-dim (ND) mode.

Press ESCAPE to exit the menu and save the desired dimmer curves.

Press RESET to exit the menu without saving.

The menu will automatically timeout after 5 minutes of inactivity and save.



**17. ND-LEVEL**

*Set the non-dim trigger level threshold for each output.*

The non-dim trigger level threshold can be set for each of the 96 dimmer (PWM) outputs. The trigger level setting is only relevant when the dimmer curve profile is set to non-dim (ND). The trigger level can be set from 10% to 100% DMX control input, with 10% increments. There is 5% hysteresis to ensure there is no false triggering. When the trigger level is set to 10%, the output is turned full-on at 10% and off at 5%. When the trigger level is set to 100%, the output is turned full-on at 100% and off at 95%. The default trigger level is 10%.

Press EXECUTE to enter the menu.

D01<010%

Displays the dimmer (D) output (01) and the trigger level setting (010%).

D96<010%

Press MENU (  $\blacklozenge$  ) to select the desired dimmer output from 01 to 96.

D96>010%

Press EXECUTE to toggle the pointer (>) to set the non-dim trigger level.

D96>100%

Press MENU (  $\blacklozenge$  ) to set the trigger level from 10% to 100% DMX control.

D96<100%

Press EXECUTE to toggle the pointer (<) to select another dimmer output.

Press ESCAPE to exit the menu and save the desired trigger level settings.

Press RESET to exit the menu without saving.

The menu will automatically timeout after 5 minutes of inactivity and save.



**NOTE:** DIM CURV must be set to ND for this menu to function.

**18. VOUT LIM**

*Set the maximum RMS output voltage for each dimmer.*

Limiting the maximum RMS voltage can greatly improve lamp life.

Press EXECUTE to enter the menu.

01<127.5

Displays the dimmer (01) and its current maximum output voltage level (127.5).

96<127.5

Press MENU (  $\blacklozenge$  ) to select the desired dimmer number from 01 to 96.

96>127.5

Press EXECUTE to toggle the pointer (< >) to select the output voltage level.

96>100.0

Press MENU (  $\blacklozenge$  ) to adjust the output voltage level in 0.5 Volt increments.

96<100.0

Press EXECUTE to toggle the pointer (< >) to select another dimmer number.

Press ESCAPE to exit the menu and save the desired dimmer curves.

Press RESET to exit the menu without saving.

The menu will automatically timeout after 5 minutes of inactivity and save.

**19. REGULATE**

*Enable or disable the dimmer output voltage regulation.*

With the on-board output voltage regulation feature enabled the maximum RMS output is limited to 118 Volts. Voltage regulation automatically adjusts the internal control level to compensate for any line voltage fluctuations.

ENABLED

Press EXECUTE to toggle regulation from ENABLED to DISABLED.

DISABLED

Press EXECUTE to toggle regulation from DISABLED to ENABLED.

Any change in the configuration is automatically saved.

**20. ANA MODE**

*Configure the analog inputs for normal or load shed mode.*

Each of the four (4) analog inputs can be independently configured for normal (NORM) or load shed (SHED) mode of operation.

Normal (NORM) mode sets the analog input for 0-10VDC operation. The analog voltage level sensed sets the level for the selected dimmer outputs.

Load shed (SHED) mode is used as a power management interface to building management systems (BMS). Contact closure devices such as a photocell or maintained switch contact may be used to trigger the analog input. When a voltage of 5.5VDC to 12VDC is sensed on the analog input the selected dimmer outputs are disabled (set to zero output level). The selected dimmer outputs are enabled when the voltage sensed on the analog input drops to below 4.5VDC.

Press EXECUTE to enter the menu and set the mode for each analog input.



A01<NORM Displays the active analog input (A01) and current mode setting (NORM).  
A04<NORM Press MENU (  $\blacklozenge$  ) to select the desired analog input to configure.  
A04<SHED Press EXECUTE to toggle from normal (NORM) to load shed (SHED) mode.  
Press ESCAPE to exit the menu and save the desired analog input modes.  
Press RESET to exit the menu without saving.  
The menu will automatically timeout after 5 minutes of inactivity and save.

## 21. ANA PAT

*Patch the analog inputs to any combination of control channels.*

Press EXECUTE to enter the menu and activate analog patch mode.

A01<C01 Displays the active analog input (A01) and control channel (C01).  
A04<C01 Press MENU (  $\blacklozenge$  ) to select the desired analog input to patch.  
A04>C01 Press EXECUTE to toggle the pointer (>) to select the control channel.  
A04>C96 Press MENU (  $\blacklozenge$  ) to select the desired control channel from 01 to 96.  
A04>C96 \* Press EXECUTE to patch and flag (\*) the control channel to the analog input.  
A04<C96 \* Press ESCAPE to toggle the pointer (< >) to select another analog input.  
Press ESCAPE to exit the menu and save the desired analog patches.  
Press RESET to exit the menu without saving.  
The menu will automatically timeout after 5 minutes of inactivity and save.

## 22. ANA TEST

*View the control level for each of the analog inputs.*

The analog voltage level for the 4 analog inputs can be tested and viewed as a percentage or hexadecimal value. The level displayed is proportional to the 0-10VDC analog input where 5VDC is 50%.

Press EXECUTE to enter the menu and activate analog test mode.

AI>01=00 Displays the active analog input (AI>01) and the level (00).  
AI>04=00 Press MENU (  $\blacklozenge$  ) to select the desired analog input to test.  
AI>04=FL Displays the analog input level from off (00) to full-on (FL).  
Press ESCAPE or RESET to exit the menu.

## 23. ANA FLTR

*Apply a noise filter on the analog inputs of up to 1 Volt.*

High frequency noise can sometimes be induced into the analog input lines. The analog filter is set in 1% increments where each percent (%) represents 0.1 Volts for a maximum filter level of 1 Volt, or 10%. For example, when the analog filter level is set at 5% (LEV:05%) all analog input levels at or below 0.5 Volts is ignored or filtered out.

LEV:00% Displays the filter level (00%) in percent.  
LEV:00%< Press EXECUTE to enter the menu and adjust the analog filter level.  
LEV:10%< Press MENU (  $\blacklozenge$  ) to select the desired filter level.  
Press ESCAPE to exit the menu and save the desired analog filter level.  
Press RESET to exit the menu without saving.  
The menu will automatically timeout after 5 minutes of inactivity and save.

## 24. ANA BLOC

*Enable or disable the analog inputs when DMX is being received.*

When analog blocking (ANA BLOC) is enabled the analog inputs will be ignored when DMX is online. When analog blocking is disabled the analog inputs will be merged/combined with the DMX inputs and functions in a highest-takes-precedence (HTP) mode of operation.

ENABLED Press EXECUTE to toggle analog blocking from ENABLED to DISABLED.  
DISABLED Press EXECUTE to toggle analog blocking from DISABLED to ENABLED.  
Any change in the configuration is automatically saved.

**25. STANDBY**

*Enable or disable the power savings standby mode.*

When standby mode is enabled the microcontroller goes to sleep within 5 seconds of inactivity on the control inputs. The microcontroller wakes up again when a programming switch is pressed or when control is sensed on the control inputs. Note that there is a delay of 150 milliseconds for the microcontroller to wake up and restart normal run mode.

ENABLED  
DISABLED

Press EXECUTE to toggle standby mode from ENABLED to DISABLED.

Press EXECUTE to toggle standby mode from DISABLED to ENABLED.

Any change in the configuration is automatically saved.

**26. TEST INC**

*Set the test increment units to percent or hexadecimal.*

The levels for the dimmer test (DIM TEST) and analog test (ANA TEST) features can be displayed as a percentage or hexadecimal value.

PERCENT  
HEX VAL

Press EXECUTE to toggle test increments from PERCENT to HEX VAL.

Press EXECUTE to toggle test increments from HEX VAL to PERCENT.

Any change in the configuration is automatically saved.

**27. OC MODE**

*Configure the input trigger parameters for the open collector output.*

The on-board open collector output is used to sink up to 100mA of current. It can be configured to be triggered via a selected DMX channel, analog input 4, or both. The open collector is triggered on at 55% control input and triggered off again at 45% control input. When analog and DMX (A+D) is selected to trigger the open collector the inputs are combine for highest takes precedence (HTP).

A+D< 001  
A+D> 001  
A+D> 512  
A+D< 512  
DMX< 512  
ANA<  
OFF<

Press EXECUTE to enter the menu and configure the open collector output.

Displays the active trigger mode as analog and DMX (A+D&lt;) channel 001.

Press EXECUTE to toggle the pointer (&gt;) and select the DMX channel.

Press MENU (  $\blacklozenge$  ) to change and select the DMX channel from 001 to 512.

Press EXECUTE to toggle the pointer (&lt;) and select a different trigger mode.

Press MENU (  $\blacklozenge$  ) to select DMX input trigger mode.Press MENU (  $\blacklozenge$  ) to select analog (ANA) input trigger mode.Press MENU (  $\blacklozenge$  ) to deactivate (OFF) the open collector output.

Press ESCAPE to exit the menu and save the desired settings.

Press RESET to exit the menu without saving.

The menu will automatically timeout after 5 minutes of inactivity and save.

**28. AUX IN**

*Select which scene the auxiliary input will trigger/enable.*

When a contact is sensed on the auxiliary input the selected scene will be triggered and held until the contact is removed. The auxiliary input only functions when scene mode (SCENESET) is activated or when the systems scene mode (SCENEMOD) is enabled and active.

SCENE:01  
SCENE>01  
SCENE>20

Displays the scene (01) that will be triggered by the auxiliary input.

Press EXECUTE to enter the menu and select a different scene.

Press MENU (  $\blacklozenge$  ) to change the selected scene from 01 to 20.

Press ESCAPE to exit the menu and save the desired scene to be triggered.

Press RESET to exit the menu without saving.

The menu will automatically timeout after 5 minutes of inactivity and save.

**29. SCENEMOD**

*Enable or disable scene mode and the auxiliary input.*

Enabling scene mode puts the system in scene mode. With scene mode enabled the selected scene will always be activated when DMX is not being received.

The selected scene can be changed in the SCENESET menu. Scene mode enables the use of the auxiliary input. A contact closure sensed on the over-temperature, fire alarm or security alarm inputs automatically takes precedence over scene mode.

ENABLED  
DISABLED

Press EXECUTE to toggle scene mode from ENABLED to DISABLED.

Press EXECUTE to toggle scene mode from DISABLED to ENABLED.

Any change in the configuration is automatically saved.



**30. S-ALARM**

*Select the level and control channels triggered by the security alarm input.*

When a contact is sensed on the security alarm input, the selected control channels will cycle on and off at a 1 hertz rate. The level of the on cycle can be set from 0% to 100%. The security alarm input takes precedence over the DMX and analog inputs. The system will stay in security alarm mode until the contact is removed.

Press EXECUTE to enter the menu and configure the security alarm input.

L>FL:01\*

Displays the output level (L>FL) of 100% and control channel (01\*).

L>00:01\*

Press MENU (  $\blacktriangle$  ) to change the output level from 00% to 100% (FL).

L>FL:01\*

Press MENU (  $\blacktriangledown$  ) at the same time to toggle the level back to 100% (FL).

L:FL>01\*

Press EXECUTE to toggle the pointer (>) and select the control channel(s).

L:FL>96\*

Press MENU (  $\blacktriangle$  ) to select the desired control channel from 01 to 96.

L:FL>96

Press EXECUTE to toggle the flag (\*) for each desired control channel.

Press ESCAPE to exit the menu and save the desired settings.

Press RESET to exit the menu without saving.

The menu will automatically timeout after 5 minutes of inactivity and save.

**31. F-ALARM**

*Select the level and control channels triggered by the fire alarm input.*

When a contact is sensed on the fire alarm input, the selected control channels are triggered on to the selected output level from 0% to 100%. The fire alarm input is merged with the DMX and analog inputs with highest takes precedence (HTP). The system will stay in fire alarm mode until the contact is removed.

Press EXECUTE to enter the menu and configure the fire alarm input.

L>FL:01\*

Displays the output level (L>FL) of 100% and control channel (01\*).

L>00:01\*

Press MENU (  $\blacktriangle$  ) to change the output level from 00% to 100% (FL).

L>FL:01\*

Press MENU (  $\blacktriangledown$  ) at the same time to toggle the level back to 100% (FL).

L:FL>01\*

Press EXECUTE to toggle the pointer (>) and select the control channel(s).

L:FL>96\*

Press MENU (  $\blacktriangle$  ) to select the desired control channel from 01 to 96.

L:FL>96

Press EXECUTE to toggle the flag (\*) for each desired control channel.

Press ESCAPE to exit the menu and save the desired settings.

Press RESET to exit the menu without saving.

The menu will automatically timeout after 5 minutes of inactivity and save.

**32. Ø-PATCH**

*Set the zero-cross phase reference for each dimmer control output circuit.*

Strand CD80 dimmer racks are typically powered by 3-phase, with the dimmer phase reference configured for AABBC (dimmers 1 and 2 are powered by phase A, dimmers 3 and 4 are powered by phase B, dimmers 5 and 6 are powered by phase C, etc). The defaults (DEFAULTS) menu is normally used to configure the phase patch for standard applications. This menu provides custom phase patching for non-standard applications.

If a dimmer control output is patched to the incorrect phase reference, the dimmer will not dim correctly and will go to full output at around 1% DMX input.

Press EXECUTE to enter the menu and configure the dimmer phase patch.

CH 01 ØA

Displays the dimmer output channel (CH 01) and patched Phase A (ØA).

CH 96 ØA

Press MENU (  $\blacktriangle$  ) to change the dimmer output channel to patch from 01 to 96.

CH 96 ØB

Press EXECUTE to toggle the patch to Phase B (ØB).

CH 96 ØC

Press EXECUTE to toggle the patch to Phase C (ØC).

Press ESCAPE to exit the menu and save the desired settings.

Press RESET to exit the menu without saving.

The menu will automatically timeout after 5 minutes of inactivity and save.





**33. WARMING**

*Turn the "lamp warming" feature on or off.*

The unique "lamp warming" feature is activated by a control level above 0% and lowers the in-rush current to the dimmer (cold lamp filament) by up to 70%. This results in significantly increased lamp filament life and lower long-term operating costs.

WARMING is set to ON by factory default, but may be turned OFF for some installation applications. With WARMING set to ON, a maximum delay of 245 milliseconds is introduced to "warm" the lamp when it is turned on. For fast chase effects the delay may be undesirable, in which case, the "lamp warming" feature can be turned off. Note that when standby mode is enabled the microcontroller goes to sleep within 5 seconds of inactivity on the control inputs, and there is delay of 150 milliseconds for the microcontroller to wake up and restart normal run mode. To ensure virtually instant dimmer control response, set STANDBY to DISABLED and WARMING to OFF.

Press EXECUTE to enter the menu and configure the lamp warming mode.

DISABLED

This menu is disabled to help prevent inadvertent changes. Proceed to enable.

ENABLED

Press and hold MENU ( ↓ ) and MENU ( ↑ ) at the same time for 4-5 seconds.

ON

Press EXECUTE to toggle the lamp warming mode from ON to OFF.

OFF

Press EXECUTE to toggle the lamp warming mode from OFF to ON.

Press ESCAPE or RESET to exit the menu.

Any change in the configuration is automatically saved.

**34. LINE V**

*View the RMS line voltage for each power phase.*

Press EXECUTE to enter the menu and view the line voltage of each phase.

ØA=120.0

Shows the line voltage of Phase A.

ØB=120.0

Press MENU ( ⬆ ) to view the line voltage of Phase B.

ØC=120.0

Press MENU ( ⬇ ) to view the line voltage of Phase C.

Press ESCAPE or RESET to exit the menu.

**35. LINE F**

*View the line frequency of phase A.*

60.0 Hz

Shows the frequency.

**36. CTL TEMP**

*View the temperature of the microcontroller.*

+91°F

Shows the temperature in degrees Fahrenheit.

+33°C

Press EXECUTE to toggle units to degrees Celsius.

**37. RTIME**

*View the total run time of the microcontroller.*

The run time counter keeps track of the total time the microcontroller is powered up. The maximum time is 99999 hours, 59 minutes, 59 seconds, or about 11.4 years.

System operation is not effected when the maximum run time is reached and can be reset to zero at the factory.

RTIME SS

Shows the number of seconds (SS) of run time.

HHHHH:MM

Shows the number of hours (HHHHH) and minutes (MM) of run time.









**48. HARD-KEY**

*View the microcontroller's unique six-character hard-key code.*

MX-3000+ retrofit control systems may be shipped with an invalid hard-key code of 000000. A valid hard-key must be entered before the run time (RTIME) counter reaches 2160 hours / 90 days. If the run time expires without a valid hard-key the LCD display will show a runtime counter error (RTC ERR!) and all dimmer control outputs will be disabled.

HARD-KEY  
HARD KEY  
K:XXXXXX  
K:XXXXXX  
K:XXXXXX  
K>XXXXXX  
K>XXXXXX  
K:>XXXXX  
K:>XXXXX  
K:>XXXXX  
K:X>XXXX  
K:X>XXXX  
K:XX>XXX  
K:XX>XXX  
K:XXX>XX  
K:XXX>XX  
K:XXXX>X  
K:XXXX>X

A dash (-) between hard and key represents a valid hard-key.  
A blank space between hard and key represents an invalid hard-key.  
Shows the unique six-character hard-key code (XXXXXX).  
Follow the procedure below to enter the menu and modify the hard-key.  
Press and hold EXECUTE and then ESCAPE at the same time for 4-5 seconds.  
A pointer (>) appears to indicate hard-key modification is activated.  
Press MENU (  ) to modify the first hard-key character.  
Press EXECUTE to advance to the second hard-key character.  
Press MENU (  ) to modify the second hard-key character.  
Press EXECUTE to advance to the third hard-key character.  
Press MENU (  ) to modify the third hard-key character.  
Press EXECUTE to advance to the fourth hard-key character.  
Press MENU (  ) to modify the fourth hard-key character.  
Press EXECUTE to advance to the fifth hard-key character.  
Press MENU (  ) to modify the fifth hard-key character.  
Press EXECUTE to advance to the sixth hard-key character.  
Press MENU (  ) to modify the sixth hard-key character.  
Press ESCAPE to exit the menu and save the desired hard-key code.  
Press RESET to exit the menu without saving.  
The menu will automatically timeout after 5 minutes of inactivity and save.



**NOTE:** Be sure to record and file the hard-key code on page 30 for future reference.

**39. SERIAL#**

XXXXXX

*View the microcontroller's unique six-character silicone serial number.*

Shows the unique six-character serial number.

**40. VERSION**

VER X.X

*View the microcontroller's software version.*

Shows the microcontroller's software version.

**41. EEPROM**

*View the type of EEPROM memory module plugged in.*

All MX-3000+ retrofit control systems come equipped with a removable EEPROM memory module. The EEPROM memory module inserts into the on-board connector located at the rear of the MX-3000+ controller chassis, and may be removed for safe storage.

The EEPROM type is programmed for parameter (P) or firmware (F) operation.

A parameter EEPROM is used to backup all of the current configuration settings.

A firmware EEPROM is used to update the current firmware version running on the MX-3000+ microcontroller to the firmware version saved on the EEPROM.

The EEPROM memory module supplied with all MX-3000+ controllers is a parameter type, with all factory default configuration settings saved onto it before shipping.

MX3000-P  
MX3000-P  
XXXXXX  
DISABLED  
MX3000-F  
VER X.X  
DISABLED  
NONE!

Indicates the EEPROM memory module is for an MX-3000+ microcontroller.

Indicates the EEPROM type is programmed for parameter (P) operation.

Press EXECUTE to display the silicone serial number parameter.

Press EXECUTE and menu feature is disabled for factory use only.

Indicates the EEPROM type is programmed for firmware (F) operation.

Press EXECUTE to display the version (VER) of the firmware.

Press EXECUTE and menu feature is disabled for factory use only.

Indicates the EEPROM memory module is not installed.



**42. FW-LOAD**

Load new firmware into the MX-3000+ via the EEPROM memory module.  
If a firmware update is required, Johnson Systems Inc. may supply an EEPROM memory module with the latest firmware version. The firmware EEPROM memory module can be inserted into the on-board connector located at the rear of the MX-3000+ controller chassis, and the firmware can be loaded into the microcontroller. Press EXECUTE to enter the menu.

- DISABLED This menu is disabled for inadvertent use. Proceed to enable.
- ENABLED Press and hold MENU ( ↓ ) and MENU ( ↑ ) at the same time for 4-5 seconds.
- MEMCHECK Automatically checks the EEPROM memory module for firmware type.
- CRC-TEST Automatically does a CRC test on the firmware code in the EEPROM.
- >>>>>>> The CRC test in progress.
- VER X.X Displays the firmware version on the EEPROM memory module.
- UPDATE?? Press EXECUTE to proceed.
- SURE ??? Press EXECUTE to proceed.
- UPDATING Firmware update in progress.
- WILL Firmware update in progress.
- AUTO Firmware update in progress.
- RESTART Firmware update in progress.
- PLEASE Firmware update in progress.
- WAIT... When firmware update is complete the RUN LED flashes and system restarts.
- NO MEM! Displayed if an EEPROM memory module is not detected.
- WRONG Displayed if the wrong type (parameter) of EEPROM memory module detected.
- MEM TYPE Displayed if the wrong type (parameter) of EEPROM memory module detected.
- WRONG Displayed if the wrong product type of EEPROM memory module detected.
- PRODUCT Displayed if the wrong product type of EEPROM memory module detected.
- CRC ERR! Displayed if the CRC test fails and the EEPROM memory module is defective.



**WARNING:** Do not reset or turn the power off while the firmware is being updated. Doing so will cause unrecoverable loss of firmware data that is being loaded into the MX-3000+ microcontroller.

**43. RESTORE**

*Restore parameters saved in the EEPROM memory module.*  
All of the configuration setting parameters can be restored from EEPROM memory module if they have been inadvertently changed or corrupted. This feature can also be used to load configuration setting parameters into a different or new control module. This reduces the configuration time for multi-system applications that require similar settings or when a replacement control module is required.

- DISABLED This menu is disabled for inadvertent use. Proceed to enable.
- ENABLED Press and hold MENU ( ↓ ) and MENU ( ↑ ) at the same time for 4-5 seconds.
- MEMCHECK Automatically checks the EEPROM memory module for parameter type.
- OKAY... The EEPROM memory module has been verified for parameter type.
- PROCEED? Press EXECUTE to proceed.
- SURE ??? Press EXECUTE to proceed.
- CRC-TEST Automatically does a CRC test on the parameter code in the EEPROM.
- WAIT CRC test in progress.
- VERIFY CRC test in progress.
- DONE!! CRC test is done and the parameter restore automatically begins.
- WILL Parameter restore in progress.
- AUTO Parameter restore in progress.
- RESTART When parameter restore is complete, the system restarts.
- SERIAL # Displayed when the silicone serial number on the EEPROM memory module is a mismatch with the silicone serial number on the MX-3000+ microcontroller.
- PROCEED? Press EXECUTE to proceed.



- NO MEM! Displayed if an EEPROM memory module is not detected.
- WRONG Displayed if the wrong type (parameter) of EEPROM memory module detected.
- MEM TYPE Displayed if the wrong type (parameter) of EEPROM memory module detected.
- WRONG Displayed if the wrong product type of EEPROM memory module detected.
- PRODUCT Displayed if the wrong product type of EEPROM memory module detected.
- ERROR Displayed when an error occurs. Waits for key press to restart RESTORE.

**44. BACKUP**

*Backup parameters and save them in the EEPROM memory module.*

All of the configuration setting parameters can be saved in the EEPROM memory module for backup. The backup parameters can then be restored if they have been inadvertently changed or corrupted. Once backup is complete the EEPROM memory module may be removed for safe storage. All MX-3000+ controllers are shipped with the factory default configuration settings saved in the EEPROM memory module.

Press EXECUTE to enter the menu.

- DISABLED This menu is disabled for inadvertent use. Proceed to enable.
- ENABLED Press and hold MENU ( ↓ ) and MENU ( ↑ ) at the same time for 4-5 seconds.
- MEMCHECK Automatically checks the EEPROM memory module for parameter type.
- SURE ??? Press EXECUTE to proceed.
- WAIT Automatically begins parameter backup and generates CRC value.
- VERIFY Automatically verifies parameter backup data and CRC value.
- DONE!! Parameter backup is done and saved in the EEPROM memory module.
- NO MEM! Displayed if an EEPROM memory module is not detected.
- WRONG Displayed if the wrong type (parameter) of EEPROM memory module detected.
- MEM TYPE Displayed if the wrong type (parameter) of EEPROM memory module detected.
- WRONG Displayed if the wrong product type of EEPROM memory module detected.
- PRODUCT Displayed if the wrong product type of EEPROM memory module detected.
- DATA ERR Displayed when a data error occurs. Waits for key press to restart BACKUP.



**NOTE:** Backup all MX-3000+ retrofit control systems when configuration is complete.

**45. PRINTOUT**

*Print various system configuration settings using a hand held infrared printer.*

All MX-3000+ retrofit control systems come equipped with an infrared (I/R) LED that provides the ability to printout all the system configuration settings, when used in conjunction with a hand held infrared printer (Johnson System Inc., Part Number: JS-IP). Point the hand held printer I/R LED directly at the MX-3000+ controller PRINTER I/R LED within 3 ft (1m).

Press EXECUTE to enter the menu.

Press MENU ( ⬆ ) to scroll through and select which item(s) to printout.

- SYSTEM? Prints general system information and configuration settings.
- ANALOGS? Prints the channel patch for all 4 analog inputs.
- Ø-PATCH? Prints the phase patch for all 96 dimmer outputs.
- CURVES? Prints the dimmer curves for all 96 dimmer outputs.
- F-ALARM? Prints the configuration settings for the fire alarm input.
- S-ALARM? Prints the configuration settings for the security alarm input.
- SCENE? Prints the level settings for each of the 96 dimmers within the 20 scenes.
- SCENE>01 Press EXECUTE to toggle the pointer (>) and select which scene to print.
- SCENE>FL Press MENU ( ⬆ ) to select the desired scene (01 to 20) or all scenes (FL).
- V-LIMIT? Prints the output voltage limit settings for each of the 96 dimmer outputs.
- DCPATCH? Prints the configuration settings for the dimmer to channel patch.
- FD-TIME? Prints the fade time settings for each of the 20 scenes.
- 2 ROOM? Prints the two room assignment for each of the 96 dimmer outputs.



DMXAPAT? Prints the DMX A patch for each of the 96 dimmer outputs.  
DMXBPAT? Prints the DMX B patch for each of the 96 dimmer outputs.  
ND-LEVEL Prints the non-dim trigger level threshold setting for each of the 96 dimmer outputs.  
ALL? Printout all items at once.  
PRINTING Press EXECUTE on any item to begin printing.  
Press ESCAPE or RESET to exit the menu.

#### 46. DEFAULTS

*Set various system configuration settings to the factory default.*

Press EXECUTE to enter the menu.

Press MENU (  ) to scroll through and select which item(s) to default.

ØPATCH1? Sets the dimmer phase patch to AABBCC. This is the default setting.

ØPATCH2? Sets the dimmer phase patch to AAAAAA.

CURVES? Sets all 96 dimmer curve profiles to Square Law curve.

ANA-OFF? Clears the control channel patch for all 4 analog inputs.

V-LIMIT? Sets the output voltage limit to full (127.5) on all 96 dimmer outputs.

DCPATCH? Clears the dimmer to channel patch and configures it for 1:1 operation.

FD-TIME? Sets the fade time at 5 seconds for all 20 scenes.

2 ROOM? Sets the two room assignment to room "A" on all 96 dimmer outputs.

ND-LEVEL Sets the non-dim trigger level threshold to 10% on all 96 dimmer outputs.

SURE??? Press EXECUTE to select the item to default. Are you sure?

DONE!!! Press EXECUTE to set the selected default.

Press ESCAPE or RESET to exit the menu.

#### 47. LCD VIEW

*Adjust the contrast of the LCD Display for optimum viewing.*

Press EXECUTE to enter the menu.

ADJUST Press MENU (  ) to adjust the contrast.

Press ESCAPE to exit the menu and save the desired LCD view.

Press RESET to exit the menu without saving.

The menu will automatically timeout after 5 minutes of inactivity and save.

## Important Hard-key Information

MX-3000+ retrofit control systems may be shipped with an invalid hard-key code of 000000. A valid hard-key must be entered before the run time (RTIME) counter reaches 2,160 hours / 90 days. If the run time expires without a valid hard-key, the LCD display will show a runtime counter error (RTC ERR!) and all dimmer control outputs will be disabled.

Refer to menu item "HARD-KEY" on page 26 of the user manual for detailed instructions on how to enter a valid hard-key code. Be sure to record and file the valid hard-key code for future reference.

JSI Serial Number: \_\_\_\_\_

Silicone Serial Number: \_\_\_\_\_

Hard-Key Code: \_\_\_\_\_

JSI Serial Number: \_\_\_\_\_

Silicone Serial Number: \_\_\_\_\_

Hard-Key Code: \_\_\_\_\_

JSI Serial Number: \_\_\_\_\_

Silicone Serial Number: \_\_\_\_\_

Hard-Key Code: \_\_\_\_\_

JSI Serial Number: \_\_\_\_\_

Silicone Serial Number: \_\_\_\_\_

Hard-Key Code: \_\_\_\_\_

JSI Serial Number: \_\_\_\_\_

Silicone Serial Number: \_\_\_\_\_

Hard-Key Code: \_\_\_\_\_

JSI Serial Number: \_\_\_\_\_

Silicone Serial Number: \_\_\_\_\_

Hard-Key Code: \_\_\_\_\_

JSI Serial Number: \_\_\_\_\_

Silicone Serial Number: \_\_\_\_\_

Hard-Key Code: \_\_\_\_\_

JSI Serial Number: \_\_\_\_\_

Silicone Serial Number: \_\_\_\_\_

Hard-Key Code: \_\_\_\_\_

JSI Serial Number: \_\_\_\_\_

Silicone Serial Number: \_\_\_\_\_

Hard-Key Code: \_\_\_\_\_

JSI Serial Number: \_\_\_\_\_

Silicone Serial Number: \_\_\_\_\_

Hard-Key Code: \_\_\_\_\_

JSI Serial Number: \_\_\_\_\_

Silicone Serial Number: \_\_\_\_\_

Hard-Key Code: \_\_\_\_\_

JSI Serial Number: \_\_\_\_\_

Silicone Serial Number: \_\_\_\_\_

Hard-Key Code: \_\_\_\_\_

JSI Serial Number: \_\_\_\_\_

Silicone Serial Number: \_\_\_\_\_

Hard-Key Code: \_\_\_\_\_

JSI Serial Number: \_\_\_\_\_

Silicone Serial Number: \_\_\_\_\_

Hard-Key Code: \_\_\_\_\_

JSI Serial Number: \_\_\_\_\_

Silicone Serial Number: \_\_\_\_\_

Hard-Key Code: \_\_\_\_\_

JSI Serial Number: \_\_\_\_\_

Silicone Serial Number: \_\_\_\_\_

Hard-Key Code: \_\_\_\_\_





**User Manual**  
 MX-3000+ Control Retrofit for  
 Electronics Diversified Inc. (EDI) and  
 Cooper MX Series Dimmer Racks  
 Rev. 1

[www.johnsonsystems.com](http://www.johnsonsystems.com)



**JOHNSON SYSTEMS INC.**

"PROFESSIONAL LIGHT CONTROL PRODUCTS"

1923 Highfield Crescent S.E.  
 Calgary, Alberta, Canada T2G 5M1  
 tel: 403.287.8003  
 fax: 403.287.9003  
 e-mail: [info@johnsonsystems.com](mailto:info@johnsonsystems.com)  
 website: [www.johnsonsystems.com](http://www.johnsonsystems.com)

